

### 325/326 Series Lead-Free 3AB, Slo-Blo® Fuse



#### Description

The 3AB Slo-Blo® Fuse with ceramic body construction permits higher interrupting ratings and voltage ratings. Ideal for applications where high current loads are expected.







#### Features

- In accordance with UL Standard 248-14
- Available in cartridge and axial lead format and with various forming dimensions
- RoHS compliant and Lead-free

#### Applications

Used as supplementary protection in appliance or utilization equipment to provide individual protection for components or internal circuits.







#### Agency Approvals

Agency	Agency File Number	Ampere Range
	E10480	250mA - 10A
	E10480	12A - 30A
	LR 29862	250mA - 30A
	NBK 030805- E10480A-F/ NBK 260106- JP1021A/B	1A - 30A
	SU05001-5010 SU05001-5011 SU05001-5012 SU05001-7005	2.5A - 3.2A/ 7A - 20A
		10mA - 30A

#### Electrical Characteristics for Series

% of Ampere Rating	Ampere Rating	Opening Time
100%	100mA – 30A	4 hours, Minimum
135%	100mA – 30A	1 hour, Maximum
200%	100mA – 3.2A	5 sec., Min., 30 sec., Max.
	4A – 30A	5 sec., Min., 60 sec., Max.

### Electrical Characteristic Specifications by Item

Amp Code	Ampere Rating (A)	Voltage Rating (V)	Interrupting Rating	Nominal Cold Resistance (Ohms)	Nominal Melting I <sup>2</sup> t (A <sup>2</sup> sec)	Agency Approvals							
													
.010	0.01	250	100A@250Vac	3324.8000	0.00148						x		
.031	0.031	250		332.5000	0.0110							x	
.062	0.062	250		91.7000	0.0276							x	
.100	0.1	250		33.5500	0.0870							x	
.125	0.125	250		22.4500	0.100							x	
.150	0.15	250		15.4500	0.143							x	
.175	0.175	250		8.9200	0.220							x	
.187	0.187	250		7.7250	0.230							x	
.200	0.2	250		6.7700	0.213							x	
.250	0.25	250		4.4300	0.432				x	x	x		
.300	0.3	250	3.2200	0.690				x	x	x			
.375	0.375	250	2.1550	1.20				x	x	x			
.400	0.4	250	1.9350	1.33				x	x	x			
.500	0.5	250	1.3000	2.50				x	x	x			
.600	0.6	250	0.9495	3.90				x	x	x			
.700	0.7	250	0.7215	6.42				x	x	x			
.750	0.75	250	0.6410	7.00				x	x	x			
.800	0.8	250	100A@250Vac 10KA@125Vac 10KA@125Vdc	0.5725	8.20			x	x	x			
001.	1	250		0.3890	16.3	x		x	x	x			
01.2	1.2	250		0.2860	22.0	x		x	x	x			
1.25	1.25	250		0.2680	24.0	x		x	x	x			
01.5	1.5	250		0.1975	40.1	x		x	x	x			
01.6	1.6	250		0.1760	45.0	x		x	x	x			
002.	2	250		0.1210	80.0	x		x	x	x			
02.5	2.5	250		0.0835	136.0	x		x	x	x	x		
02.8	2.8	250		0.0695	170.0	x		x	x	x	x		
003.	3	250		0.0605	200.0	x		x	x	x	x		
03.2	3.2	250	100A@250Vac 10KA@125Vac	0.0539	214.0	x		x	x	x	x		
004.	4	250	400A@250Vac 10KA@125Vac	0.0761	9.71	x		x	x	x			
005.	5	250		0.0522	25.0	x		x	x	x			
6.25	6.25	250		0.0346	60.4	x		x	x	x			
007.	7	250		0.0227	47.3	x		x	x	x	x		
008.	8	250		0.0193	67.1	x		x	x	x	x	x	
010.	10	250		0.0132	137	x		x	x	x	x	x	
012.	12	250	400A@250Vac 10KA@125Vac 600A@125Vdc	0.0067	129	x	x	x		x	x		
012.*	12	250	1500A@250Vac	0.0011	445		x	x		x			
015.	15	250	400A@250Vac 10KA@125Vac 600A@125Vdc	0.0050	245	x	x	x		x	x		
015.*	15	250	1500A@250Vac	0.0083	760		x	x		x			
020.	20	250	400A@250Vac 10KA@125Vac 600A@125Vdc	0.0034	575	x	x	x		x	x		
020.*	20	250	1500A@250Vac	0.0042	2500		x	x		x			
025.	25	250	400A@250Vac 10KA@60Vdc 600A@125Vdc	0.0024	1030	x	x	x		x			
030.	30	250		0.0019	1690	x	x	x		x			

\*Higher I<sup>2</sup>t version available. Please add suffix "D" to part numbers. For instance, 0325020.MXDP, 0326020.MXDP  
I<sup>2</sup>t test at 10x rated current.

**Temperature Derating Curve**

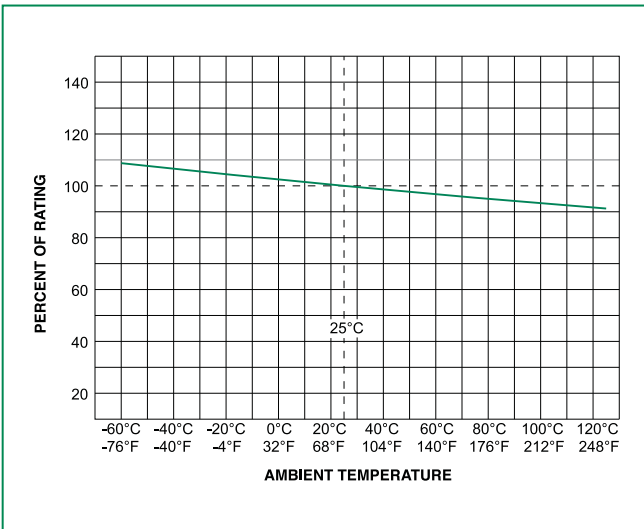

**Average Time Current Curves**

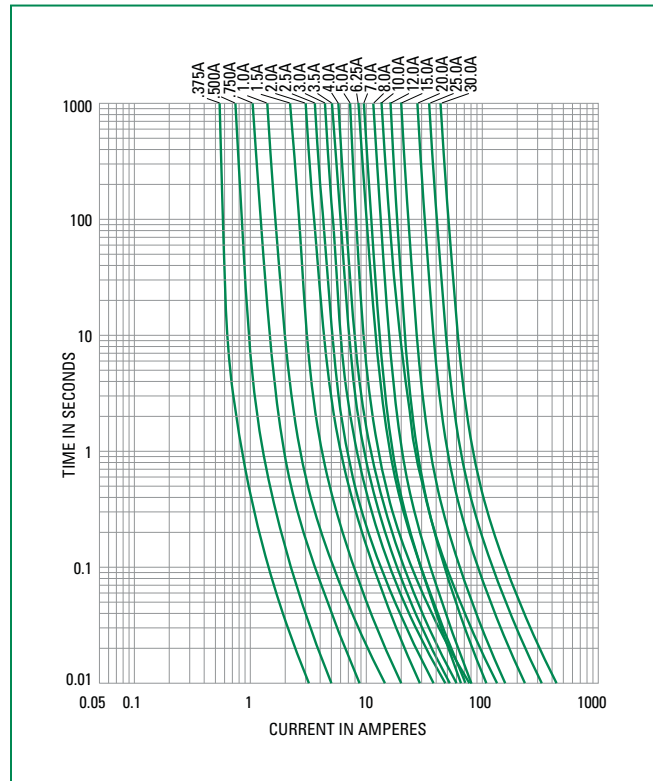

**Soldering Parameters - Wave Soldering**

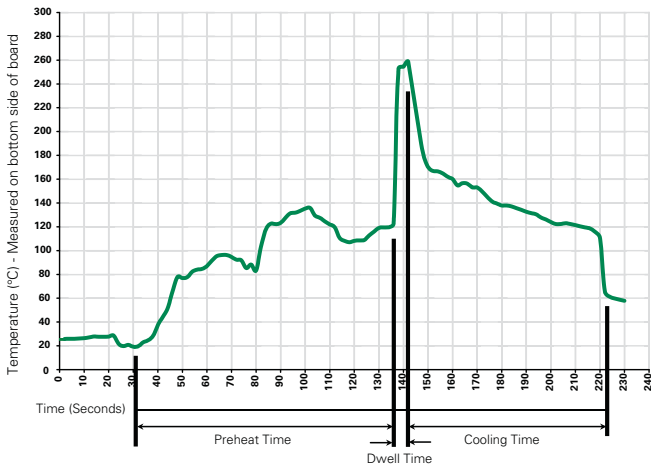

**Recommended Process Parameters:**

Wave Parameter	Lead-Free Recommendation
<b>Preheat:</b> (Depends on Flux Activation Temperature) (Typical Industry Recommendation)	
Temperature Minimum:	100° C
Temperature Maximum:	150° C
Preheat Time:	60-180 seconds
Solder Pot Temperature:	260° C Maximum
Solder Dwell Time:	2-5 seconds

**Recommended Hand-Solder Parameters:**

Solder Iron Temperature: 350° C +/- 5° C  
Heating Time: 5 seconds max.

**Note: These devices are not recommended for IR or Convection Reflow process.**

### Product Characteristics

<b>Materials</b>	Body: Ceramic Cap: Nickel-plated brass Leads: Tin-plated Copper
<b>Terminal Strength</b>	MIL-STD-202G, Method 211A, Test Condition A
<b>Solderability</b>	Reference IEC 60127 Second Edition 2003-01 Annex A
<b>Product Marking</b>	Cap1: Brand logo, current and voltage ratings Cap2: Series and agency approval marks

<b>Operating Temperature</b>	-55°C to +125°C
<b>Thermal Shock</b>	MIL-STD-202G, Method 107G, Test Condition B:(5 cycles - 65°C to 125°C)
<b>Vibration:</b>	MIL-STD-202G, Method 201A
<b>Humidity</b>	MIL-STD-202G, Method 103B, Test Condition A: High RH (95%) and Elevated temperature(40°C) for 240 hours
<b>Salt Spray</b>	MIL-STD-202G, Method 101D, Test Condition B

### Dimensions

Measurements displayed in millimeters (inches)

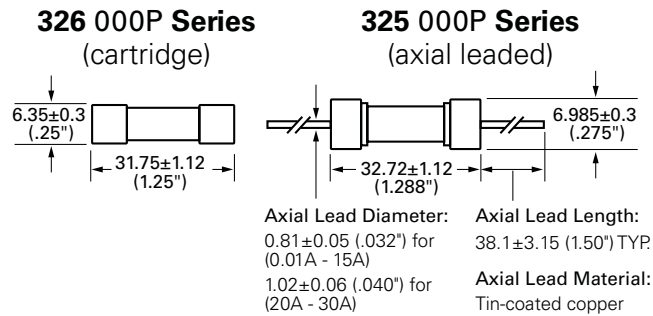

### Part Numbering System

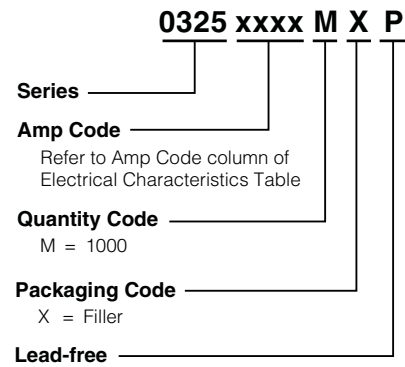

### Packaging

Packaging Option	Packaging Specification	Quantity	Quantity & Packaging Code	Taping Width
<b>325 Series</b>				
Bulk	N/A	1000	MX	N/A
Bulk	N/A	100	HX	N/A
<b>326 Series</b>				
Bulk	N/A	1000	MX	N/A
Bulk	N/A	100	HX	N/A