

RoHS  **313/315 Series Lead-Free 3AG, Slo-Blo® Fuse**









### Description

The 3AG Slo-Blo® fuse solves a broad range of application requirements while offering reliable performance and cost-effective circuit protection.

The fuse catalog number with the suffix “ID” instantly identifies itself upon opening by showing a discoloration of its glass body. Guesswork and time consuming circuit testing are eliminated. This unique design offers the same quality performance characteristics as the standard 3AG Slo-Blo® Fuse design.

### Agency Approvals

Agency	Agency File Number	Ampere Range
	E10480	10mA - 10A**
	LR 29862	10mA - 10A**/15A**
	E10480	10A - 30A
	NBK 040205- E10480B/D/F/G/H	1A - 10A**/ 15A**
	SU05001- 5007/5008/5009/6004	2.25A - 8A
		10mA - 10A**/15A**

### Features

- In accordance with UL Standard 248-14
- Available in cartridge and axial lead format and with various forming dimensions
- RoHS compliant and Lead-free

### Applications

Used as supplementary protection in appliance or utilization equipment to provide individual protection for components or internal circuits.

### Electrical Characteristics by Series

% of Ampere Rating	Ampere Rating	Opening Time
100%	10mA – 30A	4 hours, Minimum
135%	10mA – 30A	1 hour, Maximum
200%	10mA – 15A	5 sec., Min., 30 sec., Max
	20A – 30A	5 sec., Min., 60 sec Max

**313/315 Series**

### Electrical Characteristic Specifications by Item

Amp Code	Ampere Rating (A)	Voltage Rating (V)	Interrupting Rating	Nominal Cold Resistance (Ohms)	Nominal Melting I <sup>2</sup> t (A <sup>2</sup> sec)	Agency Approvals					
						UL	SF	CCC	RU	PS E	CE
.010	0.01	250	35A@250Vac 10KA@125Vac	4300.0000	0.000121	x	x				x
.031	0.031	250		430.0000	0.00303	x	x				x
.040	0.04	250		300.0000	0.00630	x	x				x
.062	0.062	250		120.0000	0.0210	x	x				x
.100	0.1	250		43.0000	0.0850	x	x				x
.125	0.125	250		30.0000	0.152	x	x				x
.150	0.15	250		20.0000	0.270	x	x				x
.175	0.175	250		8.6700	0.177	x	x				x
.187	0.187	250		8.0100	0.230	x	x				x
.200	0.2	250		6.5900	0.270	x	x				x
.250	0.25	250		4.2700	0.385	x	x				x
.300	0.3	250		3.1350	0.730	x	x				x
.375	0.375	250		2.0950	1.23	x	x				x
.400	0.4	250		1.8750	1.35	x	x				x
.500*	0.5	250		1.2600	2.55	x	x				x
.600	0.6	250		0.9120	4.00	x	x				x
.700	0.7	250		0.7000	5.90	x	x				x
.750	0.75	250		0.6215	7.16	x	x				x
.800	0.8	250		0.5540	8.00	x	x				x
001.*	1	250		0.3750	14.0	x	x			x	x
01.2	1.2	250	0.2780	21.5	x	x			x	x	
1.25	1.25	250	0.2600	24.0	x	x			x	x	
01.5*	1.5	250	0.1910	38.0	x	x			x	x	
01.6	1.6	250	0.1710	49.6	x	x			x	x	
01.8	1.8	250	0.1410	58.0	x	x			x	x	
002.*	2	250	0.1169	77.0	x	x			x	x	
2.25	2.25	250	0.0968	121	x	x	x		x	x	
02.5	2.5	250	0.0811	130	x	x	x		x	x	
02.8	2.8	250	0.0675	170	x	x	x		x	x	
003.*	3	250	0.0593	200	x	x	x		x	x	
03.2	3.2	250	0.0529	209	x	x	x		x	x	
004.*	4	250	0.0311	76.1	x	x	x		x	x	
005.*	5	250	0.0214	140	x	x	x		x	x	
6.25*	6.25	250	0.0154	242	x	x	x		x	x	
06.3	6.3	250	0.0154	242	x	x	x		x	x	
007.*	7	250	0.0128	347	x	x	x		x	x	
008.*	8	250	0.0111	445	x	x	x		x	x	
010.**	10	250	0.0083	760	x	x			x	x	
010.*	10	32	0.0083	760				x			
012.	12	32	0.0065	1200				x			
015.**	15	125	0.0050	1870		x		x	x	x	
015.	15	32	0.0050	1870				x			
020.	20	32	0.0022	9560				x			
025.	25	32	0.0017	16500				x			
030.	30	32	0.0012	26900				x			

\* For 313series, these ratings available with an indicating option. Add the "ID" designation to the series number. i.e. 313.500ID.

\*\* These 2 ratings are designed for special voltage requirement. For 10A, it is available as 250Vac rated and the part number is 0313010.MX250P; for 15A, it is available as 125Vac rated and the part number is 0315015.MX125P.

### Temperature Derating Curve

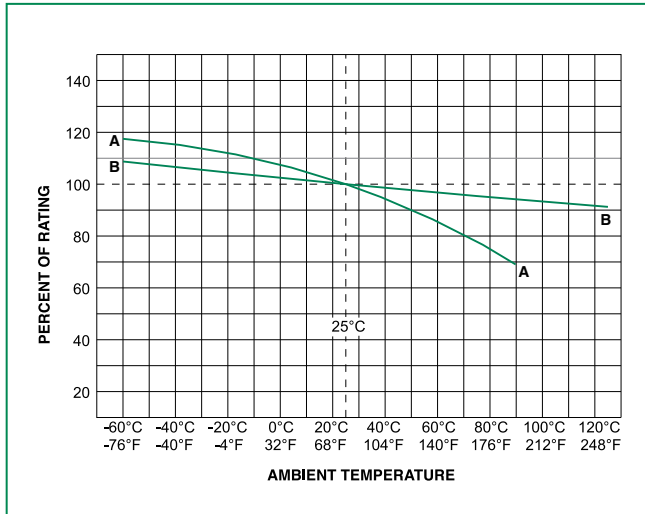

- A - For 313/315 Series, from 10mA to 150mA**
- B - For all other ampere ratings of 313/315 series**

### Average Time Current Curves

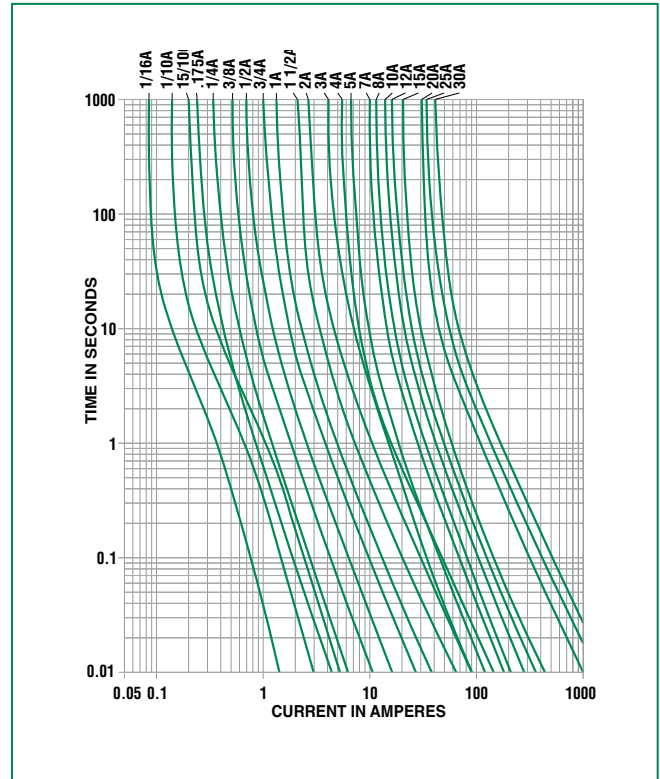

### Soldering Parameters - Wave Soldering

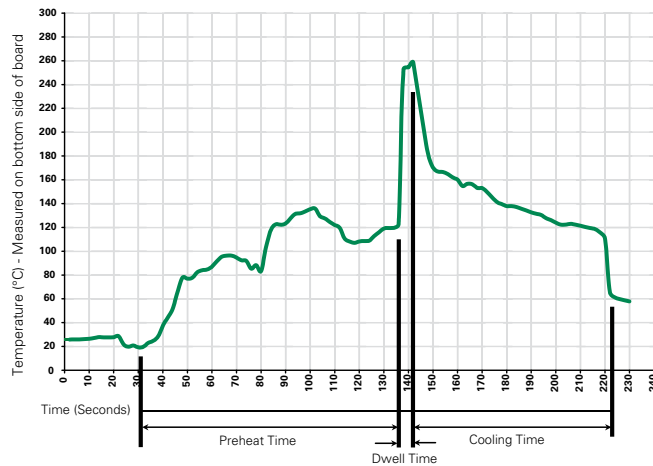

#### Recommended Process Parameters:

Wave Parameter	Lead-Free Recommendation
<b>Preheat:</b> (Depends on Flux Activation Temperature) (Typical Industry Recommendation)	
Temperature Minimum:	100° C
Temperature Maximum:	150° C
Preheat Time:	60-180 seconds
<b>Solder Pot Temperature:</b>	260° C Maximum
<b>Solder Dwell Time:</b>	2-5 seconds

#### Recommended Hand-Solder Parameters:

Solder Iron Temperature: 350° C +/- 5° C  
 Heating Time: 5 seconds max.

**Note: These devices are not recommended for IR or Convection Reflow process.**

### Product Characteristics

<b>Materials</b>	Body: Glass Cap: Nickel-plated brass Leads: Tin-plated Copper
<b>Terminal Strength</b>	MIL-STD-202G, Method 211A, Test Condition A
<b>Solderability</b>	Reference IEC 60127 Second Edition 2003-01 Annex A
<b>Product Marking</b>	Cap1: Brand logo, current and voltage ratings Cap2: Series and agency approval marks

<b>Operating Temperature</b>	-55°C to +125°C
<b>Thermal Shock</b>	MIL-STD-202G, Method 107G, Test Condition B: (5 cycles -65°C to +125°C)
<b>Vibration</b>	MIL-STD-202G, Method 201 A
<b>Humidity</b>	MIL-STD-202G, Method 103B, Test Condition A: High RH (95%) and Elevated temperature (40°C) for 240 hours
<b>Salt Spray</b>	MIL-STD-202G, Method 101D, Test Condition B

### Dimensions

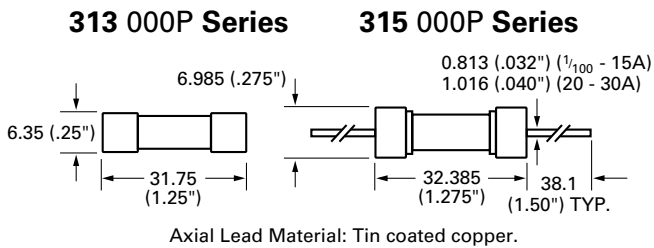

### Part Numbering System

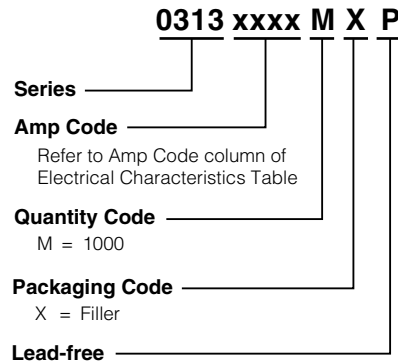

### Packaging

Packaging Option	Packaging Specification	Quantity	Quantity & Packaging Code	Taping Width
<b>313 Series</b>				
Bulk	N/A	1000	MX	N/A
Bulk	N/A	100	HX	N/A
<b>315 Series</b>				
Bulk	N/A	1000	MX	N/A
Bulk	N/A	100	HX	N/A
Bulk	N/A	1000	MXB	N/A