



### Description

The 3AG Fast-Acting Fuse solves a broad range of application requirements while offering reliable performance and cost-effective circuit protection.

### Features

- In accordance with UL Standard 248-14
- Available in cartridge and axial lead format and with various forming dimensions
- RoHS compliant and Lead-free (except 10mA and 31mA rated items)

### Applications

Used as supplementary protection in appliance or utilization equipment to provide individual protection for components or internal circuits.







### Agency Approvals

Agency	Agency File Number	Ampere Range
	E10480 AU1410	312 Series 10mA - 10A 318 Series 31mA - 10A 312 Series 12A - 30A
	LR 29862	312 Series 10mA - 30A 318 Series 31mA - 10A
	NBK040205- E10480B/F	312/318 Series 1A - 10A
	E10480	318 Series 12A - 30A
	SU05001- 5005/5006/6005/6008	312/318 Series 1A/ 1.25A / 1.6A/ 2A - 10A
		312 Series 10mA - 10A 318 Series 31mA - 35A

### Electrical Characteristics for Series

% of Ampere Rating	Ampere Rating	Opening Time
100%	.01 – 35	4 hours, Minimum
135%	.01 – 35	1 hour, Maximum
200%	.01 – 10	5 sec., Maximum
	12 – 30	10 sec., Maximum
	35	20 sec., Maximum

### Electrical Characteristic Specifications by Item

Amp Code	Ampere Rating (A)	Max Voltage Rating (V)	Interrupting Rating	Nominal Cold Resistance (Ohms)	Nominal Melting I <sup>2</sup> t (A <sup>2</sup> sec)	Agency Approvals					
											
.10*	0.01	250	10mA ~ 1A 35A@250Vac 10KA@125Vac	177.4000	NA	x**				x**	x**
.031*	0.031	250		23.6500	0.0000300	x				x	x
.062	0.062	250		24.7000	0.000249	x				x	x
.100	0.1	250		11.2800	0.00102	x				x	x
.125	0.125	250		7.1450	0.00289	x				x	x
.150	0.15	250		5.1300	0.00550	x				x	x
.175	0.175	250		3.8750	0.00960	x				x	x
.187	0.187	250		3.4200	0.0128	x				x	x
.200	0.2	250		3.0200	0.0165	x				x	x
.250	0.25	250		2.0100	0.0355	x				x	x
.300	0.3	250		1.4050	0.0689	x				x	x
.375	0.375	250		0.8250	0.185	x				x	x
.500	0.5	250		0.4980	0.483	x				x	x
.600	.6	250		0.3620	0.880	x				x	x
.750	0.75	250		0.2445	1.84	x				x	x
001	1	250		0.1900	0.760	x		x	x	x	x
1.25	1.25	250		0.1385	1.45	x		x	x	x	x
01.5	1.5	250		0.1036	2.35	x			x	x	x
01.6	1.6	250		0.0934	2.80	x		x	x	x	x
1.75	1.75	250		0.0856	3.60	x			x	x	x
01.8	1.8	250	0.0825	3.85	x			x	x	x	
002	2	250	0.0704	5.20	x		x	x	x	x	
2.25	2.25	250	0.0594	7.20	x		x	x	x	x	
02.5	2.5	250	0.0513	9.54	x		x	x	x	x	
003	3	250	0.0427	14.0	x		x	x	x	x	
004	4	250	0.0293	28.5	x		x	x	x	x	
005	5	250	0.0224	50.0	x		x	x	x	x	
006	6	250	0.0178	118.0	x		x	x	x	x	
007	7	250	0.0146	118.0	x		x	x	x	x	
008	8	250	0.0122	166.0	x		x	x	x	x	
010	10	250	0.0093	298.0	x		x	x	x	x	
012	12	32	0.0072	234.6	x**	x***			x**		
015	15	32	0.0052	490.5	x**	x***			x**		
020	20	32	0.0035	1029	x**	x***			x**		
025	25	32	0.0024	2041	x**	x***			x**		
030	30	32	0.0019	3717	x**	x***			x**		
035	35	32	0.0013	7531							

**NOTES:**

\* 10mA and 31mA are not RoHS compliant as the glass bead contains Pb.

\*\* 312 Series only. Refer to Agency Approvals section of this document.

\*\*\* 318 Series only. Refer to Agency Approvals section of this document.

### Temperature Derating Curve

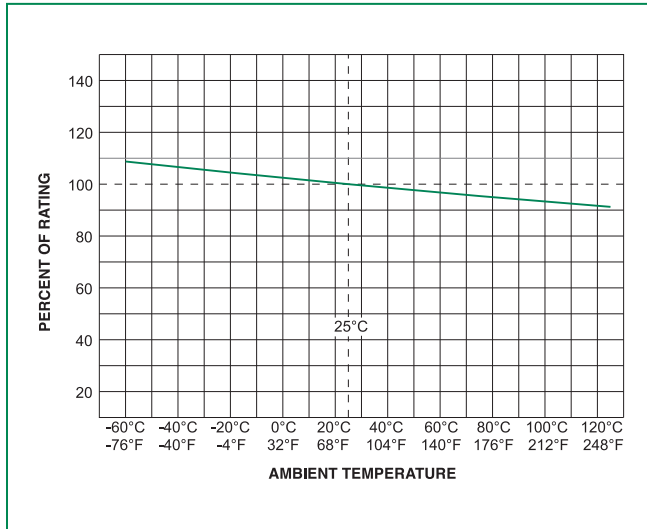

### Average Time Current Curves

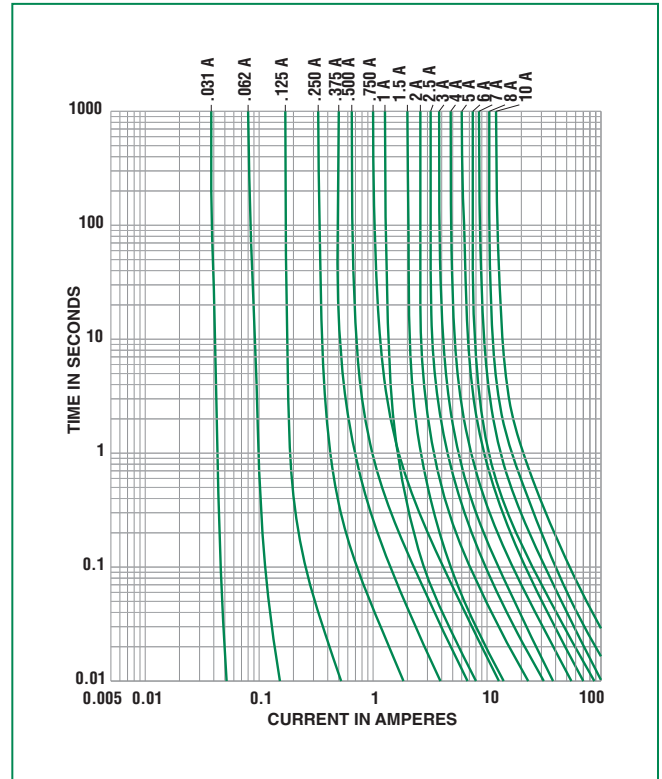

### Soldering Parameters - Wave Soldering

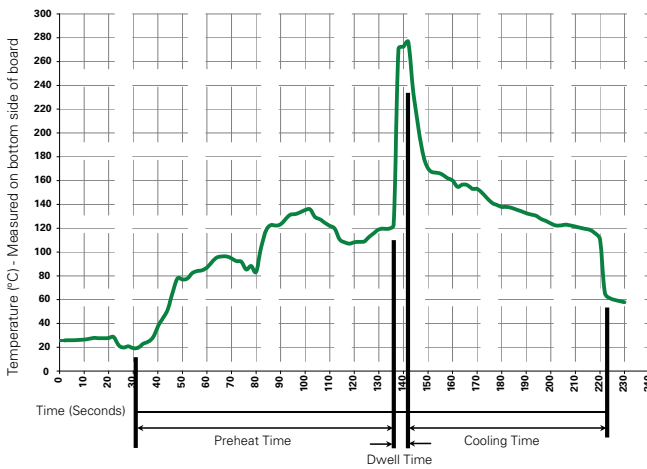

### Recommended Process Parameters:

Wave Parameter	Lead-Free Recommendation
<b>Preheat:</b> (Depends on Flux Activation Temperature) (Typical Industry Recommendation)	
Temperature Minimum:	100° C
Temperature Maximum:	150° C
Preheat Time:	60-180 seconds
<b>Solder Pot Temperature:</b>	280° C Maximum
<b>Solder Dwell Time:</b>	2-5 seconds

### Recommended Hand-Solder Parameters:

Solder Iron Temperature: 350° C +/- 5° C  
 Heating Time: 5 seconds max.

**Note: These devices are not recommended for IR or Convection Reflow process.**

## Product Characteristics

<b>Materials</b>	Body: Glass Cap: Nickel-plated brass Leads: Tin-plated Copper
<b>Terminal Strength</b>	MIL-STD-202G, Method 211A, Test Condition A
<b>Solderability</b>	Reference IEC 60127 Second Edition 2003-01 Annex A
<b>Product Marking</b>	Cap1: Brand logo, current and voltage ratings Cap2: Series and agency approval marks

<b>Operating Temperature</b>	-55°C to +125°C
<b>Thermal Shock</b>	MIL-STD-202G, Method 107G, Test Condition B: (5 cycles -65°C to +125°C)
<b>Vibration</b>	MIL-STD-202G, Method 201 A
<b>Humidity</b>	MIL-STD-202G, Method 103B, Test Condition A: High RH (95%), and Elevated temperature (40°C) for 240 hours
<b>Salt Spray</b>	MIL-STD-202G, Method 101D, Test Condition B

## Part Numbering System

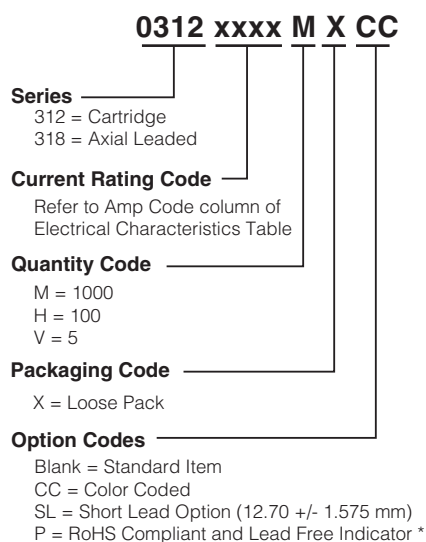

For additional information or information about other available options, please contact Littelfuse.

\*Note: All 312 / 318 series fuses are now sold as RoHS compliant and Lead Free by default, with or without the "P" indicator.

## Dimensions

Measurements displayed in millimeters (inches)

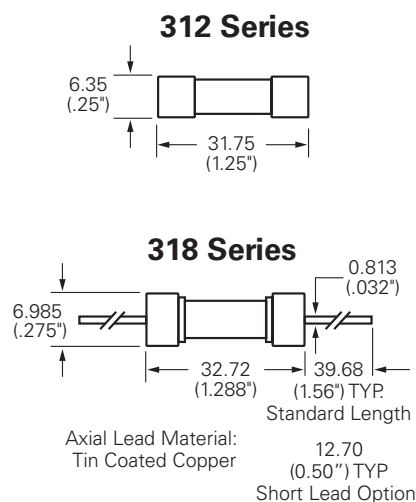

## Packaging

Packaging Option	Quantity	Quantity & Packaging Code
<b>312 Series (Cartridge Type)</b>		
Bulk	5	VX
Bulk	100	HX
Bulk	1000	MX
Bulk	1000	MXCC
Bulk	100	HXCC
<b>318 Series (Axial Leaded)</b>		
Bulk	5	VX
Bulk	100	HX
Bulk	1000	MX
Bulk	1000	MXSL