

SMD Inductors(Coils) For High Frequency(Multilayer)

Conformity to RoHS Directive

MLG Series MLG0603S

FEATURES

- Nominal inductance values are supported from 0.3 to 100nH.
- Provides high Q characteristics.
- Advanced monolithic structure is formed using a multilayering and sintering process with ceramic and conductive materials for high-frequency.
- The products contain no lead and also support lead-free soldering.
- It is a product conforming to RoHS directive.

APPLICATIONS

For high-frequency applications including mobile phones, high frequency modules (PA, VCO, FEM etc.), Bluetooth, W-LAN, UWB and tuners.

SHAPES AND DIMENSIONS

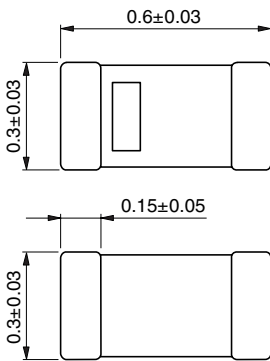

Weight: 0.2mg

RECOMMENDED PC BOARD PATTERN

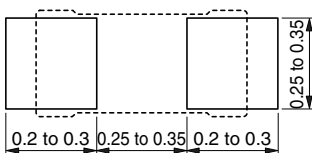

Dimensions in mm

RECOMMENDED SOLDERING CONDITION REFLOW SOLDERING

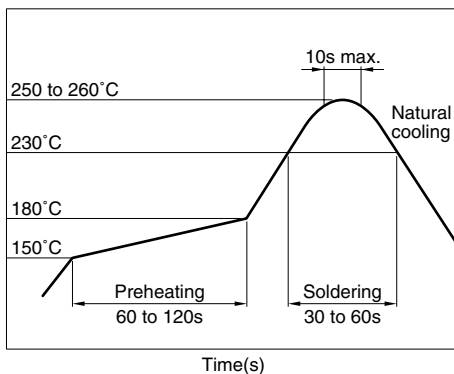

- Conformity to RoHS Directive: This means that, in conformity with EU Directive 2002/95/EC, lead, cadmium, mercury, hexavalent chromium, and specific bromine-based flame retardants, PBB and PBDE, have not been used, except for exempted applications.

- Please contact our Sales office when your application are considered the following:
The device's failure or malfunction may directly endanger human life (e.g. application for automobile/aircraft/medical/nuclear power devices, etc.)

- All specifications are subject to change without notice.

PRODUCT IDENTIFICATION

MLG	0603	S	2N2	S	T
(1)	(2)	(3)	(4)	(5)	(6)

(1) Series name

(2) Dimensions

0603	0.6×0.3mm (L×W)
------	-----------------

(3) Material code

(4) Inductance value

2N2	2.2nH
12N	12nH
R10	100nH

(5) Inductance tolerance

B	±0.1nH
C	±0.2nH
S	±0.3nH
H	±3%
J	±5%

(6) Packaging style

T	Taping (reel)
---	---------------

SPECIFICATIONS

Operating temperature range	-55 to +125°C
Storage temperature range	-55 to +125°C [Unit of products]

PACKAGING STYLE AND QUANTITIES

Packaging style	Quantity
Taping	15000 pieces/reel

HANDLING AND PRECAUTIONS

- Before soldering, be sure to preheat components.
The preheating temperature should be set so that the temperature difference between the solder temperature and product temperature does not exceed 150°C.
- After mounting components onto the printed circuit board, do not apply stress through board bending or mishandling.
- When hand soldering, apply the soldering iron to the printed circuit board only. Temperature of the iron tip should not exceed 350°C. Soldering time should not exceed 3 seconds.

ELECTRICAL CHARACTERISTICS

Inductance (nH)	Inductance tolerance	Q min.	Test frequency L, Q (MHz)	Self-resonant frequency (GHz)		DC resistance (Ω)		Rated current (mA)max.	Part No.
				min.	typ.	max.	typ.		
0.3	$\pm 0.1, \pm 0.2\text{nH}$	—	100	10.0	20up	0.1	0.02	600	MLG0603S0N3□*T
0.4	$\pm 0.1, \pm 0.2\text{nH}$	—	100	10.0	20up	0.1	0.02	600	MLG0603S0N4□T
0.5	$\pm 0.1, \pm 0.2\text{nH}$	—	100	10.0	20up	0.1	0.02	600	MLG0603S0N5□T
0.6	$\pm 0.1, \pm 0.2\text{nH}$	—	100	10.0	20up	0.1	0.02	600	MLG0603S0N6□T
0.7	$\pm 0.1, \pm 0.2\text{nH}$	—	100	10.0	16.3	0.1	0.02	600	MLG0603S0N7□T
0.8	$\pm 0.1, \pm 0.2\text{nH}$	—	100	10.0	16.1	0.1	0.03	600	MLG0603S0N8□T
0.9	$\pm 0.1, \pm 0.2\text{nH}$	—	100	10.0	13.8	0.1	0.03	600	MLG0603S0N9□T
1.0	$\pm 0.1, \pm 0.2, 0.3\text{nH}$	4	100	10.0	14.4	0.1	0.04	600	MLG0603S1N0□T
1.1	$\pm 0.1, \pm 0.2, 0.3\text{nH}$	4	100	10.0	13.6	0.15	0.04	550	MLG0603S1N1□T
1.2	$\pm 0.1, \pm 0.2, 0.3\text{nH}$	4	100	10.0	12.3	0.15	0.06	550	MLG0603S1N2□T
1.3	$\pm 0.1, \pm 0.2, 0.3\text{nH}$	4	100	9.0	11.4	0.15	0.07	550	MLG0603S1N3□T
1.5	$\pm 0.1, \pm 0.2, 0.3\text{nH}$	4	100	9.0	10.4	0.15	0.07	550	MLG0603S1N5□T
1.6	$\pm 0.1, \pm 0.2, 0.3\text{nH}$	4	100	9.0	11.5	0.2	0.09	500	MLG0603S1N6□T
1.8	$\pm 0.1, \pm 0.2, 0.3\text{nH}$	4	100	8.5	10.0	0.2	0.12	500	MLG0603S1N8□T
2.0	$\pm 0.1, \pm 0.2, 0.3\text{nH}$	4	100	8.2	9.8	0.25	0.14	400	MLG0603S2N0□T
2.2	$\pm 0.1, \pm 0.2, 0.3\text{nH}$	4	100	8.0	8.9	0.25	0.14	400	MLG0603S2N2□T
2.4	$\pm 0.1, \pm 0.2, 0.3\text{nH}$	4	100	8.0	9.2	0.25	0.15	300	MLG0603S2N4□T
2.7	$\pm 0.1, \pm 0.2, 0.3\text{nH}$	4	100	6.5	8.1	0.25	0.17	300	MLG0603S2N7□T
3.0	$\pm 0.1, \pm 0.2, 0.3\text{nH}$	4	100	6.2	7.8	0.3	0.20	300	MLG0603S3N0□T
3.3	$\pm 0.1, \pm 0.2, 0.3\text{nH}$	4	100	5.8	7.0	0.35	0.23	300	MLG0603S3N3□T
3.6	$\pm 0.1, \pm 0.2, 0.3\text{nH}$	4	100	5.5	6.9	0.35	0.22	300	MLG0603S3N6□T
3.9	$\pm 0.1, \pm 0.2, 0.3\text{nH}$	5	100	5.0	6.6	0.4	0.27	300	MLG0603S3N9□T
4.3	$\pm 3\%, \pm 0.3\text{nH}$	5	100	5.0	6.4	0.4	0.27	300	MLG0603S4N3□T
4.7	$\pm 3\%, \pm 0.3\text{nH}$	5	100	4.5	5.4	0.45	0.28	300	MLG0603S4N7□T
5.1	$\pm 3\%, \pm 0.3\text{nH}$	5	100	4.5	5.5	0.45	0.23	250	MLG0603S5N1□T
5.6	$\pm 3\%, \pm 0.3\text{nH}$	5	100	4.2	5.3	0.5	0.31	250	MLG0603S5N6□T
6.2	$\pm 3\%, \pm 0.3\text{nH}$	5	100	4.2	5.1	0.55	0.32	250	MLG0603S6N2□T
6.8	$\pm 3, \pm 5\%$	5	100	3.6	4.4	0.6	0.32	250	MLG0603S6N8□T
7.5	$\pm 3, \pm 5\%$	5	100	4.2	5.3	0.7	0.43	200	MLG0603S7N5□T
8.2	$\pm 3, \pm 5\%$	5	100	3.8	4.5	0.7	0.45	200	MLG0603S8N2□T
9.1	$\pm 3, \pm 5\%$	5	100	3.4	4.9	0.8	0.51	200	MLG0603S9N1□T
10	$\pm 3, \pm 5\%$	5	100	3.2	4.1	0.8	0.53	200	MLG0603S10N□T
12	$\pm 3, \pm 5\%$	6	100	2.8	3.6	0.9	0.63	180	MLG0603S12N□T
15	$\pm 3, \pm 5\%$	6	100	2.5	3.3	1.1	0.69	180	MLG0603S15N□T
18	$\pm 3, \pm 5\%$	6	100	2.2	2.8	1.2	0.78	150	MLG0603S18N□T
22	$\pm 3, \pm 5\%$	6	100	2.0	2.5	1.2	0.88	150	MLG0603S22N□T
27	$\pm 3, \pm 5\%$	6	100	1.8	2.2	1.5	1.00	100	MLG0603S27N□T
33	$\pm 3, \pm 5\%$	6	100	1.6	2.0	1.8	1.20	100	MLG0603S33N□T
39	$\pm 3, \pm 5\%$	6	100	1.4	1.6	2.0	1.40	50	MLG0603S39N□T
47	$\pm 3, \pm 5\%$	6	100	1.3	1.5	2.2	1.48	50	MLG0603S47N□T
56	$\pm 3, \pm 5\%$	5	100	1.2	1.4	3.2	2.11	50	MLG0603S56N□T
68	$\pm 3, \pm 5\%$	5	100	1.05	1.2	3.5	2.40	50	MLG0603S68N□T
82	$\pm 3, \pm 5\%$	5	100	0.90	1.1	4.0	2.80	50	MLG0603S82N□T
100	$\pm 3, \pm 5\%$	5	100	0.77	0.9	4.5	3.13	50	MLG0603SR10□T

* □: Please specify inductance tolerance, B ($\pm 0.1\text{nH}$), C ($\pm 0.2\text{nH}$), S ($\pm 0.3\text{nH}$), H ($\pm 3\%$) or J ($\pm 5\%$).

• Test equipment

Inductance Q : HP4291A+16197A, or equivalent

SRF: HP8720C, or equivalent

Rdc: YOKOGAWA TYPE7561, or equivalent

• Rated current : Value obtained when current flows and temperature has risen to under 20°C.

L, Q vs. FREQUENCY CHARACTERISTICS

Part No.	Inductance(nH)typ.					Q typ.				
	500MHz	800MHz	1.8GHz	2.0GHz	2.4GHz	500MHz	800MHz	1.8GHz	2.0GHz	2.4GHz
MLG0603S0N3□*T	0.3	0.3	0.3	0.3	0.3	14.5	19.9	34.1	34.8	40.4
MLG0603S0N4□T	0.4	0.4	0.4	0.4	0.4	14.0	18.9	30.1	32.1	35.9
MLG0603S0N5□T	0.5	0.5	0.45	0.45	0.45	14.1	18.4	29.3	31.7	35.4
MLG0603S0N6□T	0.6	0.6	0.5	0.5	0.5	15.6	19.8	32.8	34.2	38.6
MLG0603S0N7□T	0.7	0.6	0.6	0.6	0.6	16.3	21.4	33.1	34.7	38.6
MLG0603S0N8□T	0.7	0.7	0.7	0.7	0.7	15.4	20.4	32.1	34.1	37.8
MLG0603S0N9□T	0.8	0.8	0.8	0.8	0.8	15.1	19.3	30.1	31.8	35.3
MLG0603S1N0□T	0.9	0.9	0.9	0.9	0.9	14.3	18.3	28.8	30.3	33.8
MLG0603S1N1□T	1.0	1.0	1.0	1.0	1.0	14.4	18.7	29.1	30.5	34.1
MLG0603S1N2□T	1.1	1.1	1.1	1.1	1.1	14.2	18.3	28.6	30.3	33.5
MLG0603S1N3□T	1.2	1.2	1.2	1.2	1.2	14.3	18.3	28.6	30.0	33.2
MLG0603S1N5□T	1.4	1.4	1.4	1.4	1.4	14.8	18.8	29.0	30.4	33.5
MLG0603S1N6□T	1.5	1.5	1.5	1.5	1.5	14.3	18.4	28.6	30.1	33.4
MLG0603S1N8□T	1.7	1.7	1.7	1.7	1.7	14.7	18.9	28.7	30.1	33.1
MLG0603S2N0□T	1.9	1.9	1.9	1.9	1.9	13.9	18.0	27.7	29.2	32.2
MLG0603S2N2□T	2.1	2.0	2.1	2.1	2.1	13.8	17.7	26.8	27.9	30.7
MLG0603S2N4□T	2.2	2.2	2.2	2.3	2.3	13.9	17.9	27.4	28.5	31.5
MLG0603S2N7□T	2.5	2.5	2.6	2.6	2.7	14.6	18.6	27.8	28.8	31.4
MLG0603S3N0□T	2.8	2.8	2.9	2.9	3.0	15.1	19.4	29.4	30.6	33.4
MLG0603S3N3□T	3.1	3.1	3.2	3.3	3.4	15.1	19.2	28.2	29.2	31.4
MLG0603S3N6□T	3.4	3.4	3.5	3.6	3.7	13.8	17.8	26.2	27.0	29.0
MLG0603S3N9□T	3.7	3.7	3.8	3.9	4.1	15.1	19.4	28.5	29.4	31.6
MLG0603S4N3□T	4.1	4.1	4.3	4.4	4.6	14.3	18.3	26.5	27.3	28.9
MLG0603S4N7□T	4.4	4.4	4.8	4.9	5.2	15.2	19.5	27.9	28.6	30.1
MLG0603S5N1□T	4.8	4.8	5.1	5.3	5.6	13.8	17.5	25.0	25.5	26.7
MLG0603S5N6□T	5.3	5.3	5.7	5.9	6.4	15.5	19.6	27.2	27.8	28.8
MLG0603S6N2□T	5.9	5.9	6.5	6.8	7.5	14.5	18.3	25.1	25.4	25.7
MLG0603S6N8□T	6.4	6.5	7.4	7.8	8.7	15.4	19.4	25.7	25.7	25.3
MLG0603S7N5□T	7.1	7.1	7.8	8.0	8.7	14.2	18.0	25.2	25.6	26.4
MLG0603S8N2□T	7.8	7.8	8.8	9.3	10.4	14.7	18.2	23.9	24.0	23.6
MLG0603S9N1□T	8.6	8.6	9.8	10.3	11.5	13.5	16.9	22.2	22.3	21.8
MLG0603S10N□T	9.5	9.6	11.5	12.3	14.5	14.9	18.4	22.8	22.4	20.8
MLG0603S12N□T	11.4	11.7	14.2	15.4	18.7	15.6	19.3	23.5	22.7	20.4
MLG0603S15N□T	14.4	14.8	20.1	23.0	32.6	15.2	18.5	19.9	18.3	13.9
MLG0603S18N□T	17.3	18.0	28.3	35.3	72.3	14.2	17.0	15.4	12.9	6.7
MLG0603S22N□T	21.3	22.5	40.4	55.8	231.8	14.8	17.3	13.4	10.1	2.1
MLG0603S27N□T	26.5	28.6	68.3	130.9		14.6	16.7	9.3	4.9	
MLG0603S33N□T	32.6	36.0	144.5			14.2	15.9	5.2	0.5	
MLG0603S39N□T	39.5	46.5				13.1	13.7			
MLG0603S47N□T	48.6	59.5				12.8	12.5			
MLG0603S56N□T	59.2	77.2				12.0	10.9			
MLG0603S68N□T	74.4	103.9				12.5	10.7			
MLG0603S82N□T	95.5	161.3				11.8	8.2			
MLG0603SR10□T	129.3	353.5				10.5	4.4			

* □: Please specify inductance tolerance, B (± 0.1 nH), C (± 0.2 nH), S (± 0.3 nH), H ($\pm 3\%$) or J ($\pm 5\%$).

TYPICAL ELECTRICAL CHARACTERISTICS INDUCTANCE vs. FREQUENCY CHARACTERISTICS

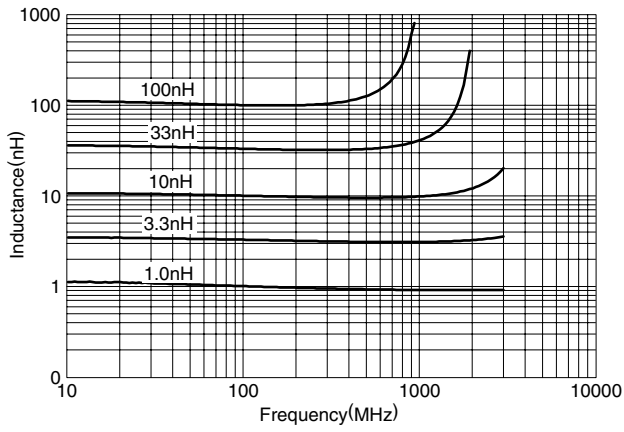

Q vs. FREQUENCY CHARACTERISTICS

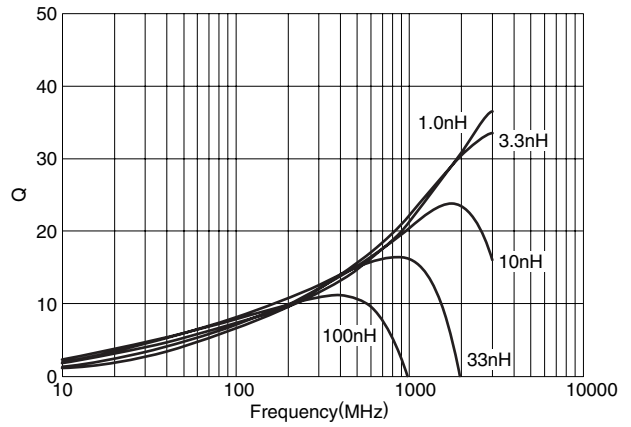

PACKAGING STYLES REEL DIMENSIONS

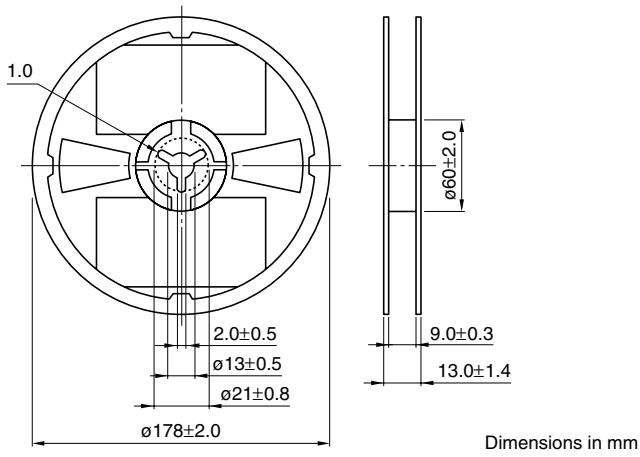

TAPE DIMENSIONS

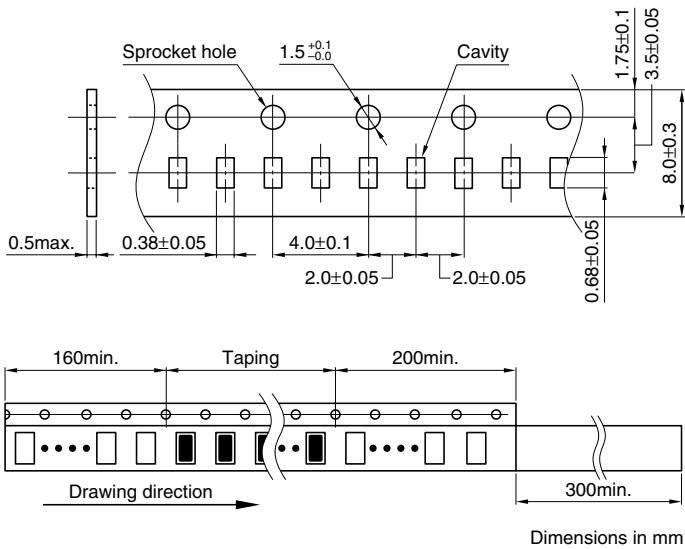

• All specifications are subject to change without notice.