

AVX

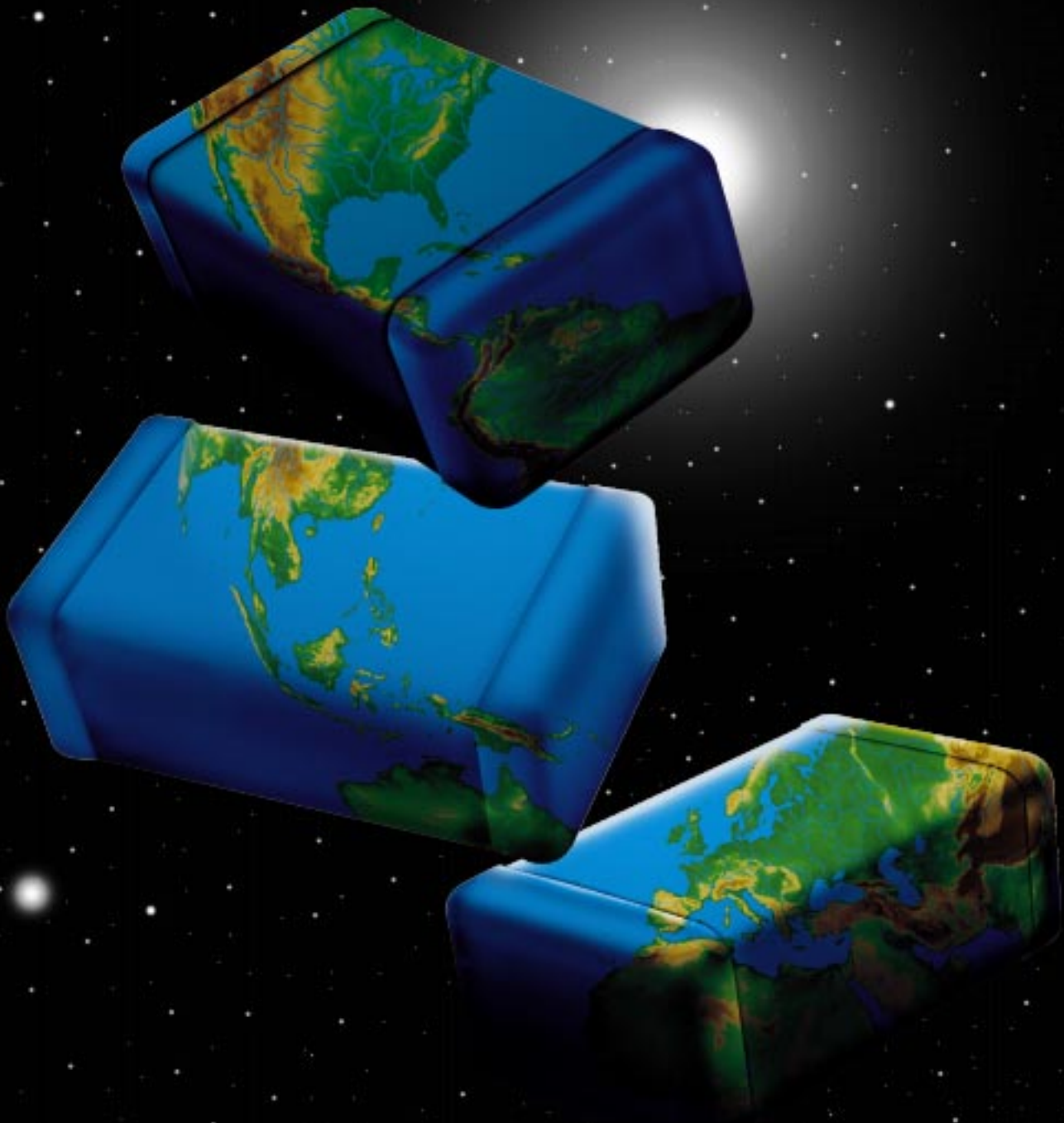

AVX
Multilayer Ceramic
Chip Capacitor

Table of Contents

- Basic Capacitor Formulas** 2
- How to Order - AVX Part Number Explanation** 3
- C0G (NP0) Dielectric**
 - General Specifications 4
 - Typical Characteristic Curves. 5
 - Capacitance Range 6 - 7
- X7R Dielectric**
 - General Specifications 8
 - Typical Characteristic Curves. 9
 - Capacitance Range 10 - 11
- Z5U Dielectric**
 - General Specifications 12
 - Typical Characteristic Curves 13
 - Capacitance Range 14 - 15
- Y5V Dielectric**
 - General Specifications 16
 - Typical Characteristic Curves 17
 - Capacitance Range 18
- Low Profile Chips for Z5U & Y5V Dielectric** 19
- High Voltage Chips for 500V to 5000V Applications** 20 - 21
- General Specifications**
 - Environmental 22 - 23
 - Mechanical 24
- MIL-PRF-55681/Chips**
 - Part Number Example 25
 - Military Part Number Identification (CDR01 thru CDR06) 26
 - Military Part Number Identification (CDR31 thru CDR35) 27
 - Military Part Number Identification (CDR31) 28
 - Military Part Number Identification (CDR32) 29
 - Military Part Number Identification (CDR33/34/35) 30
- European Version CECC 32 101-801 Chips** 31
- Packaging of Chip Components Automatic Insertion Packaging** 32
- Embossed Carrier Configuration - 8 & 12mm Tape** 33
- Paper Carrier Configuration - 8 & 12mm Tape** 34
- Bulk Case Packaging** 35
- MLC Chip Capacitors General Description** 36 - 40
- Surface Mounting Guide** 41 - 43

I. Capacitance (farads)

English: $C = \frac{.224 \text{ K A}}{T_D}$

Metric: $C = \frac{.0884 \text{ K A}}{T_D}$

II. Energy stored in capacitors (Joules, watt - sec)

$E = \frac{1}{2} CV^2$

III. Linear charge of a capacitor (Amperes)

$I = C \frac{dV}{dt}$

IV. Total Impedance of a capacitor (ohms)

$Z = \sqrt{R_s^2 + (X_C - X_L)^2}$

V. Capacitive Reactance (ohms)

$X_C = \frac{1}{2 \pi fC}$

VI. Inductive Reactance (ohms)

$X_L = 2 \pi fL$

VII. Phase Angles:

Ideal Capacitors: Current leads voltage 90°

Ideal Inductors: Current lags voltage 90°

Ideal Resistors: Current in phase with voltage

VIII. Dissipation Factor (%)

$D.F. = \tan \delta \text{ (loss angle)} = \frac{E.S.R.}{X_C} = (2 \pi fC) (E.S.R.)$

IX. Power Factor (%)

P.F. = Sine δ (loss angle) = Cos ϕ (phase angle)

P.F. = (when less than 10%) = DF

X. Quality Factor (dimensionless)

$Q = \text{Cotan } \delta \text{ (loss angle)} = \frac{1}{D.F.}$

XI. Equivalent Series Resistance (ohms)

$E.S.R. = (D.F.) (X_C) = (D.F.) / (2 \pi fC)$

XII. Power Loss (watts)

Power Loss = $(2 \pi fCV^2) (D.F.)$

XIII. KVA (Kilowatts)

$KVA = 2 \pi fCV^2 \times 10^{-3}$

XIV. Temperature Characteristic (ppm/°C)

$T.C. = \frac{C_t - C_{25}}{C_{25} (T_t - 25)} \times 10^6$

XV. Cap Drift (%)

$C.D. = \frac{C_1 - C_2}{C_1} \times 100$

XVI. Reliability of Ceramic Capacitors

$\frac{L_o}{L_t} = \left(\frac{V_t}{V_o} \right)^X \left(\frac{T_t}{T_o} \right)^Y$

XVII. Capacitors in Series (current the same)

Any Number: $\frac{1}{C_T} = \frac{1}{C_1} + \frac{1}{C_2} \dots \frac{1}{C_N}$

Two: $C_T = \frac{C_1 C_2}{C_1 + C_2}$

XVIII. Capacitors in Parallel (voltage the same)

$C_T = C_1 + C_2 \dots + C_N$

XIX. Aging Rate

A.R. = % Δ C/decade of time

XX. Decibels

$db = 20 \log \frac{V_1}{V_2}$

METRIC PREFIXES

SYMBOLS

| | | | | | | | |
|-------|-------------------|-------|------------------------|----------|--|-------|-------------------------|
| Pico | $\times 10^{-12}$ | K | = Dielectric Constant | f | = frequency | L_t | = Test life |
| Nano | $\times 10^{-9}$ | A | = Area | L | = Inductance | V_t | = Test voltage |
| Micro | $\times 10^{-6}$ | T_D | = Dielectric thickness | δ | = Loss angle | V_o | = Operating voltage |
| Milli | $\times 10^{-3}$ | V | = Voltage | ϕ | = Phase angle | T_t | = Test temperature |
| Deci | $\times 10^{-1}$ | t | = time | X & Y | = exponent effect of voltage and temp. | T_o | = Operating temperature |
| Deca | $\times 10^{+1}$ | R_s | = Series Resistance | L_o | = Operating life | | |
| Deca | $\times 10^{+1}$ | | | | | | |
| Kilo | $\times 10^{+3}$ | | | | | | |
| Mega | $\times 10^{+6}$ | | | | | | |
| Giga | $\times 10^{+9}$ | | | | | | |
| Tera | $\times 10^{+12}$ | | | | | | |

How to Order

Part Number Explanation



EXAMPLE: 08055A101JAT2A

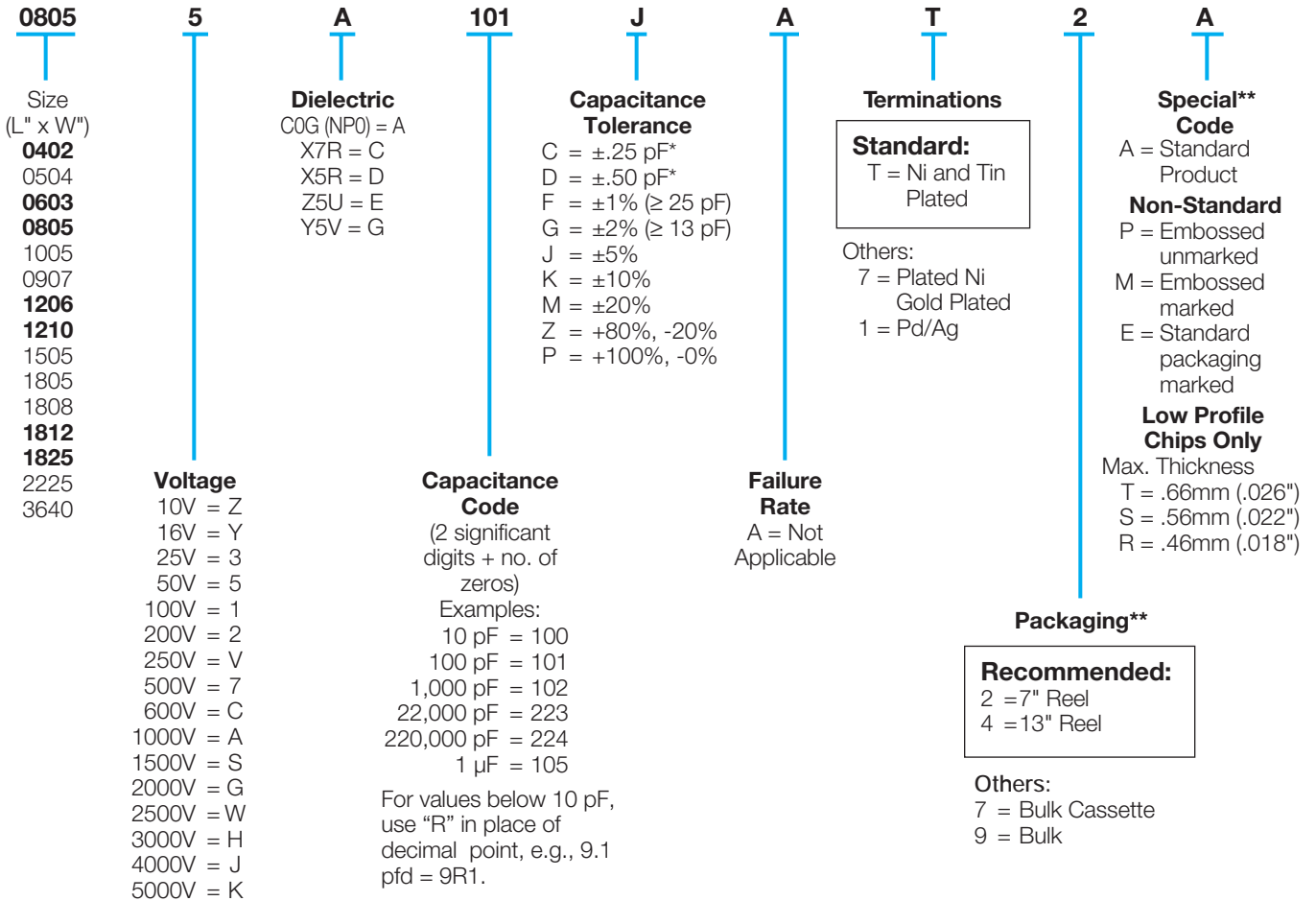

* C&D tolerances for ≤ 10 pF values.

** Standard Tape and Reel material depends upon chip size and thickness. See individual part tables for tape material type for each capacitance value.

Note: Unmarked product is standard. Marked product is available on special request, please contact AVX. Standard packaging is shown in the individual tables.

Non-standard packaging is available on special request, please contact AVX.

C0G (NP0) Dielectric



General Specifications

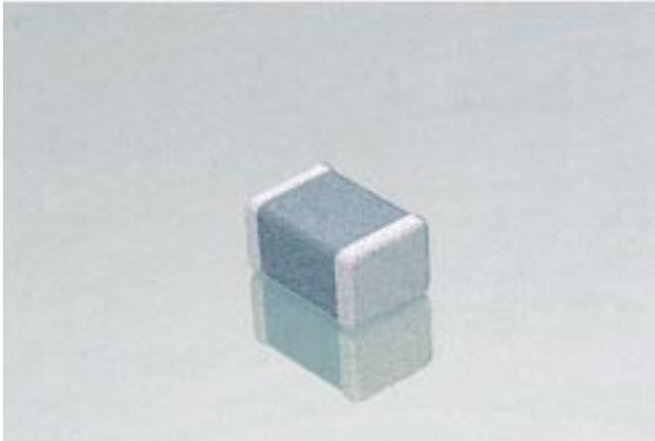

C0G (NP0) is the most popular formulation of the “temperature-compensating,” EIA Class I ceramic materials. Modern C0G (NP0) formulations contain neodymium, samarium and other rare earth oxides.

C0G (NP0) ceramics offer one of the most stable capacitor dielectrics available. Capacitance change with temperature is $0 \pm 30 \text{ ppm}/^\circ\text{C}$ which is less than $\pm 0.3\% \Delta C$ from -55°C to $+125^\circ\text{C}$. Capacitance drift or hysteresis for C0G (NP0) ceramics is negligible at less than $\pm 0.05\%$ versus up to $\pm 2\%$ for films. Typical capacitance change with life is less than $\pm 0.1\%$ for C0G (NP0), one-fifth that shown by most other dielectrics. C0G (NP0) formulations show no aging characteristics.

The C0G (NP0) formulation usually has a “Q” in excess of 1000 and shows little capacitance or “Q” changes with frequency. Their dielectric absorption is typically less than 0.6% which is similar to mica and most films.

PART NUMBER (see page 3 for complete part number explanation)

0805

Size
(L" x W")

5

Voltage
25V = 3
50V = 5
100V = 1
200V = 2

A

Dielectric
C0G (NP0) = A

101

Capacitance Code

J

Capacitance Tolerance
Preferred
K = $\pm 10\%$
J = $\pm 5\%$

A

Failure Rate
A = Not Applicable

T

Terminations
T = Plated Ni and Solder

2

Packaging
2 = 7" Reel
4 = 13" Reel

A

Special Code
A = Std. Product

PERFORMANCE CHARACTERISTICS

| | |
|--|---|
| Capacitance Range | 0.5 pF to .1 μF (1.0 ± 0.2 Vrms, 1kHz, for ≤ 100 pF use 1 MHz) |
| Capacitance Tolerances | Preferred $\pm 5\%$, $\pm 10\%$ others available: $\pm .25$ pF, $\pm .5$ pF, $\pm 1\%$ (≥ 25 pF), $\pm 2\%$ (≥ 13 pF), $\pm 20\%$ For values ≤ 10 pF preferred tolerance is $\pm .5$ pF, also available $\pm .25$ pF. |
| Operating Temperature Range | -55°C to $+125^\circ\text{C}$ |
| Temperature Characteristic | 0 ± 30 ppm/ $^\circ\text{C}$ (EIA C0G) |
| Voltage Ratings | 25, 50, 100 & 200 VDC ($+125^\circ\text{C}$) |
| Dissipation Factor and “Q” | For values > 30 pF: 0.1% max. ($+25^\circ\text{C}$ and $+125^\circ\text{C}$) For values ≤ 30 pF: “Q” = $400 + 20 \times C$ (C in pF) |
| Insulation Resistance (+25$^\circ\text{C}$, RVDC) | 100,000 megohms min. or 1000 $\text{M}\Omega$ - μF min., whichever is less |
| Insulation Resistance (+125$^\circ\text{C}$, RVDC) | 10,000 megohms min. or 100 $\text{M}\Omega$ - μF min., whichever is less |
| Dielectric Strength | 250% of rated voltage for 5 seconds at 50 mamp max. current |
| Test Voltage | 1 ± 0.2 Vrms |
| Test Frequency | For values ≤ 100 pF: 1 MHz For values > 100 pF: 1 KHz |

C0G (NP0) Dielectric



Typical Characteristic Curves**

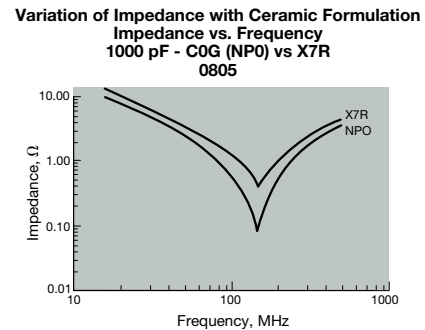
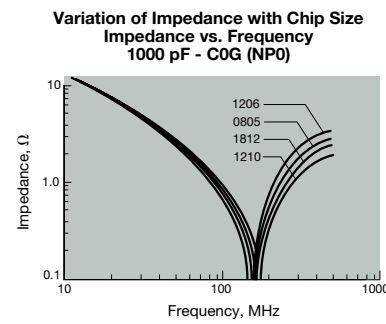
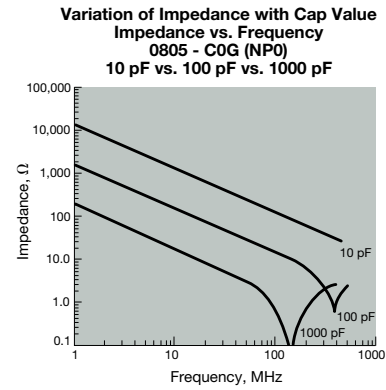
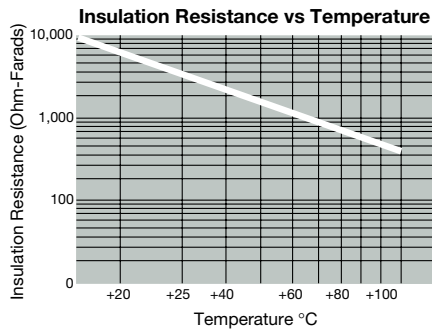
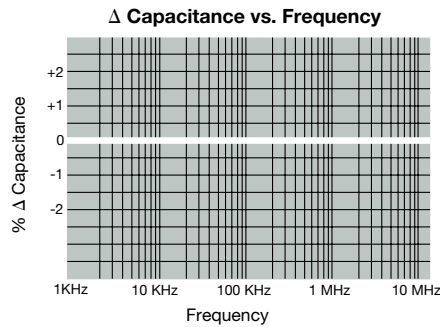
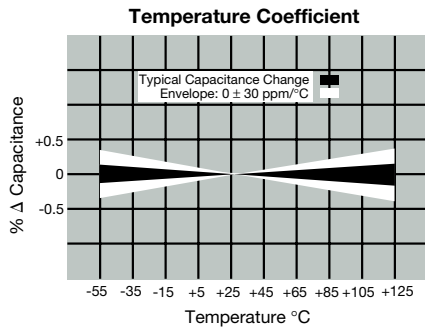

SUMMARY OF CAPACITANCE RANGES VS. CHIP SIZE

| Style | 25V | 50V | 100V | 200V |
|-------|---------------|---------------|---------------|---------------|
| 0402* | 0.5pF - 220pF | 0.5pF - 120pF | — | — |
| 0504 | 0.5pF - 330pF | 0.5pF - 150pF | 0.5pF - 68pF | — |
| 0603* | 0.5pF - 1nF | 0.5pF - 1nF | 0.5pF - 330pF | — |
| 0805* | 0.5pF - 4.7nF | 0.5pF - 2.2nF | 0.5pF - 1nF | 0.5pF - 470pF |
| 1206* | 0.5pF - 10nF | 0.5pF - 4.7nF | 0.5pF - 2.2nF | 0.5pF - 1nF |
| 1210* | 560pF - 10nF | 560pF - 10nF | 560pF - 3.9nF | 560pF - 1.5nF |
| 1505 | — | 10pF - 1.5nF | 10pF - 820pF | 10pF - 560pF |
| 1808 | → | 1nF - 4.7nF | 1nF - 3.9nF | 1nF - 2.2nF |
| 1812* | 1nF - 15nF | 1nF - 10nF | 1nF - 4.7nF | 1nF - 3.3nF |
| 1825* | → | 1nF - 22nF | 1nF - 12nF | 1nF - 6.8nF |
| 2220 | → | 4.7nF - 47nF | 4.7nF - 39nF | 3.3nF - 27nF |
| 2225 | → | 1nF - 100nF | 1nF - 39nF | 1nF - 39nF |

* Standard Sizes

** For additional information on performance changes with operating conditions consult AVX's software SpiCap.

COG (NP0) Dielectric



Capacitance Range

PREFERRED SIZES ARE SHADED

| SIZE | | 0402* | | 0504* | | | 0603* | | | 0805 | | | | 1206 | | | 1505 | | | | | | | | | | | | | | | | | | | | | | | | | | | | | | | | | | | | | | | | | | | | | | | | | | | | | | | | | | | | | | | | | | | | | | | | | | | | | | | | | | | | | | | | | | | | | | | | | | | | | | | | | | | | | | | | | | | | | | | | | | | | | | | | | | | | | | | | | | | | | | | | | | | | | | | | | | | | | | | | | | | | | | | | | | | | | | | | | | | | | | | | | | | | | | | | | | | | | | | | | | | | | | | | | | | | | | | | | | | | | | | | | | | | | | | | | | | | | | | | | | | | | | | | | | | | | | | | | | | | | | | | | | | | | | | | | | | | | | | | | | | | | | | | | | | | | | | | | | | | | | | | | | | | | | | | | | | | | | | | | | | | | | | | | | | | | | | | | | | | | | | | | | | | | | | | | | | | | | | | | | | | | | | | | | | | | | | | | | | | | | | | | | | | | | | | | | | | | | | | | | | | | | | | | | | | | | | | | | | | | | | | | | | | | | | | | | | | | | | | | | | | | | | | | | | | | | | | | | | | | | | | | | | | | | | | | | | | | | | | | | | | | | | | | | | | | | | | | | | | | | | | | | | | | | | | | | | | | | | | | | | | | | | | | | | | | | | | | | | | | | | | | | | | | | | | | | | | | | | | | | | | | | | | | | | | | | | | | | | | | | | | | | | | | | | | | | | | | | | | | | | | | | | | | | | | | | | | | | | | | | | | | | | | | | | | | | | | | | | | | | | | | | | | | | | | | | | | | | | | | | | | | | | | | | | | | | | | | | | | | | | | | | | | | | | | | | | | | | | | | | | | | | | | | | | | | | | | | | | | | | | | | | | | | | | | | | | | | | | | | | | | | | | | | | | | | | | | | | | | | | | | | | | | | | | | | | | | | | | | | | | | | | | | | | | | | | | | | | | | | | | | | | | | | | | | | | | | | | | | | | | | | | | | | | | | | | | | | | | | | | | | | | | | | | | | | | | | | | | | | | | | | | | | | | | | | | | | | | | | | | | | | | | | | | | | | | | | | | | | | | | | | | | | | | | | | | | | | | | | | | | | | | | | | | | | | | | | | | | | | | | | | | | | | | | | | | | | | | | | | | | | | | | | | | | | | | | | | | | | | | | | | | | | | | | | | | | | | | | | | | | | | | | | | | | | | | | | | | | | | | | | | | | | | | | | | | | | | | | | | | | | | | | | | | | | | | |
|-------------------------|-------------|---|----|-----------------------------|----|-----|-----------------------------|----|-----|-----------------------------|----|-----|-----|-----------------------------|----|-----|-----------------------------|----|-----|-----|--|-----|--|--|--|--|--|--|--|--|--|--|--|--|--|--|--|--|--|--|--|--|-----|--|--|--|--|--|--|--|--|--|--|--|--|--|--|--|--|--|--|--|--|-----|--|--|--|--|--|--|--|--|--|--|--|--|--|--|--|--|--|--|--|--|-----|--|--|--|--|--|--|--|--|--|--|--|--|--|--|--|--|--|--|--|--|-----|--|--|--|--|--|--|--|--|--|--|--|--|--|--|--|--|--|--|--|--|-----|--|--|--|--|--|--|--|--|--|--|--|--|--|--|--|--|--|--|--|--|-----|--|--|--|--|--|--|--|--|--|--|--|--|--|--|--|--|--|--|--|--|-----|--|--|--|--|--|--|--|--|--|--|--|--|--|--|--|--|--|--|--|--|-----|--|--|--|--|--|--|--|--|--|--|--|--|--|--|--|--|--|--|--|--|-----|--|--|--|--|--|--|--|--|--|--|--|--|--|--|--|--|--|--|--|--|-----|--|--|--|--|--|--|--|--|--|--|--|--|--|--|--|--|--|--|--|--|-----|--|--|--|--|--|--|--|--|--|--|--|--|--|--|--|--|--|--|--|--|-----|--|--|--|--|--|--|--|--|--|--|--|--|--|--|--|--|--|--|--|--|----|--|--|--|--|--|--|--|--|--|--|--|--|--|--|--|--|--|--|--|--|----|--|--|--|--|--|--|--|--|--|--|--|--|--|--|--|--|--|--|--|--|----|--|--|--|--|--|--|--|--|--|--|--|--|--|--|--|--|--|--|--|--|----|--|--|--|--|--|--|--|--|--|--|--|--|--|--|--|--|--|--|--|--|----|--|--|--|--|--|--|--|--|--|--|--|--|--|--|--|--|--|--|--|--|----|--|--|--|--|--|--|--|--|--|--|--|--|--|--|--|--|--|--|--|--|----|--|--|--|--|--|--|--|--|--|--|--|--|--|--|--|--|--|--|--|--|----|--|--|--|--|--|--|--|--|--|--|--|--|--|--|--|--|--|--|--|--|----|--|--|--|--|--|--|--|--|--|--|--|--|--|--|--|--|--|--|--|--|----|--|--|--|--|--|--|--|--|--|--|--|--|--|--|--|--|--|--|--|--|----|--|--|--|--|--|--|--|--|--|--|--|--|--|--|--|--|--|--|--|--|----|--|--|--|--|--|--|--|--|--|--|--|--|--|--|--|--|--|--|--|--|-----|--|--|--|--|--|--|--|--|--|--|--|--|--|--|--|--|--|--|--|--|-----|--|--|--|--|--|--|--|--|--|--|--|--|--|--|--|--|--|--|--|--|-----|--|--|--|--|--|--|--|--|--|--|--|--|--|--|--|--|--|--|--|--|-----|--|--|--|--|--|--|--|--|--|--|--|--|--|--|--|--|--|--|--|--|-----|--|--|--|--|--|--|--|--|--|--|--|--|--|--|--|--|--|--|--|--|-----|--|--|--|--|--|--|--|--|--|--|--|--|--|--|--|--|--|--|--|--|-----|--|--|--|--|--|--|--|--|--|--|--|--|--|--|--|--|--|--|--|--|-----|--|--|--|--|--|--|--|--|--|--|--|--|--|--|--|--|--|--|--|--|-----|--|--|--|--|--|--|--|--|--|--|--|--|--|--|--|--|--|--|--|--|-----|--|--|--|--|--|--|--|--|--|--|--|--|--|--|--|--|--|--|--|--|-----|--|--|--|--|--|--|--|--|--|--|--|--|--|--|--|--|--|--|--|--|-----|--|--|--|--|--|--|--|--|--|--|--|--|--|--|--|--|--|--|--|--|------|--|--|--|--|--|--|--|--|--|--|--|--|--|--|--|--|--|--|--|--|------|--|--|--|--|--|--|--|--|--|--|--|--|--|--|--|--|--|--|--|--|------|--|--|--|--|--|--|--|--|--|--|--|--|--|--|--|--|--|--|--|--|------|--|--|--|--|--|--|--|--|--|--|--|--|--|--|--|--|--|--|--|--|------|--|--|--|--|--|--|--|--|--|--|--|--|--|--|--|--|--|--|--|--|------|--|--|--|--|--|--|--|--|--|--|--|--|--|--|--|--|--|--|--|--|------|--|--|--|--|--|--|--|--|--|--|--|--|--|--|--|--|--|--|--|--|------|--|--|--|--|--|--|--|--|--|--|--|--|--|--|--|--|--|--|--|--|------|--|--|--|--|--|--|--|--|--|--|--|--|--|--|--|--|--|--|--|--|------|--|--|--|--|--|--|--|--|--|--|--|--|--|--|--|--|--|--|--|--|------|--|--|--|--|--|--|--|--|--|--|--|--|--|--|--|--|--|--|--|--|------|--|--|--|--|--|--|--|--|--|--|--|--|--|--|--|--|--|--|--|--|-------|--|--|--|--|--|--|--|--|--|--|--|--|--|--|--|--|--|--|--|--|
| Standard Reel Packaging | | All Paper | | All Embossed | | | All Paper | | | Paper/Embossed | | | | Paper/Embossed | | | All Embossed | | | | | | | | | | | | | | | | | | | | | | | | | | | | | | | | | | | | | | | | | | | | | | | | | | | | | | | | | | | | | | | | | | | | | | | | | | | | | | | | | | | | | | | | | | | | | | | | | | | | | | | | | | | | | | | | | | | | | | | | | | | | | | | | | | | | | | | | | | | | | | | | | | | | | | | | | | | | | | | | | | | | | | | | | | | | | | | | | | | | | | | | | | | | | | | | | | | | | | | | | | | | | | | | | | | | | | | | | | | | | | | | | | | | | | | | | | | | | | | | | | | | | | | | | | | | | | | | | | | | | | | | | | | | | | | | | | | | | | | | | | | | | | | | | | | | | | | | | | | | | | | | | | | | | | | | | | | | | | | | | | | | | | | | | | | | | | | | | | | | | | | | | | | | | | | | | | | | | | | | | | | | | | | | | | | | | | | | | | | | | | | | | | | | | | | | | | | | | | | | | | | | | | | | | | | | | | | | | | | | | | | | | | | | | | | | | | | | | | | | | | | | | | | | | | | | | | | | | | | | | | | | | | | | | | | | | | | | | | | | | | | | | | | | | | | | | | | | | | | | | | | | | | | | | | | | | | | | | | | | | | | | | | | | | | | | | | | | | | | | | | | | | | | | | | | | | | | | | | | | | | | | | | | | | | | | | | | | | | | | | | | | | | | | | | | | | | | | | | | | | | | | | | | | | | | | | | | | | | | | | | | | | | | | | | | | | | | | | | | | | | | | | | | | | | | | | | | | | | | | | | | | | | | | | | | | | | | | | | | | | | | | | | | | | | | | | | | | | | | | | | | | | | | | | | | | | | | | | | | | | | | | | | | | | | | | | | | | | | | | | | | | | | | | | | | | | | | | | | | | | | | | | | | | | | | | | | | | | | | | | | | | | | | | | | | | | | | | | | | | | | | | | | | | | | | | | | | | | | | | | | | | | | | | | | | | | | | | | | | | | | | | | | | | | | | | | | | | | | | | | | | | | | | | | | | | | | | | | | | | | | | | | | | | | | | | | | | | | | | | | | | | | | | | | | | | | | | | | | | | | | | | | | | | | | | | | | | | | | | | | | | | | | | | | | | | | | | | | | | | | | | | | | | | | | | | | | | | | | | | | | | | | | | | | | | | | | | | | | | | | | | | | | | | | | | | | | | | | | | | | | | | | | | | | | | | | | | | | | | | | | | | | | | | | | | | | | |
| (L) Length | MM (in.) | 1.00 ± .10 (.040 ± .004) | | 1.27 ± .25 (.050 ± .010) | | | 1.60 ± .15 (.063 ± .006) | | | 2.01 ± .20 (.079 ± .008) | | | | 3.20 ± .20 (.126 ± .008) | | | 3.81 ± .25 (.150 ± .010) | | | | | | | | | | | | | | | | | | | | | | | | | | | | | | | | | | | | | | | | | | | | | | | | | | | | | | | | | | | | | | | | | | | | | | | | | | | | | | | | | | | | | | | | | | | | | | | | | | | | | | | | | | | | | | | | | | | | | | | | | | | | | | | | | | | | | | | | | | | | | | | | | | | | | | | | | | | | | | | | | | | | | | | | | | | | | | | | | | | | | | | | | | | | | | | | | | | | | | | | | | | | | | | | | | | | | | | | | | | | | | | | | | | | | | | | | | | | | | | | | | | | | | | | | | | | | | | | | | | | | | | | | | | | | | | | | | | | | | | | | | | | | | | | | | | | | | | | | | | | | | | | | | | | | | | | | | | | | | | | | | | | | | | | | | | | | | | | | | | | | | | | | | | | | | | | | | | | | | | | | | | | | | | | | | | | | | | | | | | | | | | | | | | | | | | | | | | | | | | | | | | | | | | | | | | | | | | | | | | | | | | | | | | | | | | | | | | | | | | | | | | | | | | | | | | | | | | | | | | | | | | | | | | | | | | | | | | | | | | | | | | | | | | | | | | | | | | | | | | | | | | | | | | | | | | | | | | | | | | | | | | | | | | | | | | | | | | | | | | | | | | | | | | | | | | | | | | | | | | | | | | | | | | | | | | | | | | | | | | | | | | | | | | | | | | | | | | | | | | | | | | | | | | | | | | | | | | | | | | | | | | | | | | | | | | | | | | | | | | | | | | | | | | | | | | | | | | | | | | | | | | | | | | | | | | | | | | | | | | | | | | | | | | | | | | | | | | | | | | | | | | | | | | | | | | | | | | | | | | | | | | | | | | | | | | | | | | | | | | | | | | | | | | | | | | | | | | | | | | | | | | | | | | | | | | | | | | | | | | | | | | | | | | | | | | | | | | | | | | | | | | | | | | | | | | | | | | | | | | | | | | | | | | | | | | | | | | | | | | | | | | | | | | | | | | | | | | | | | | | | | | | | | | | | | | | | | | | | | | | | | | | | | | | | | | | | | | | | | | | | | | | | | | | | | | | | | | | | | | | | | | | | | | | | | | | | | | | | | | | | | | | | | | | | | | | | | | | | | | | | | | | | | | | | | | | | | | | | | | | | | | | | | | | | | | | | | | | | | | | | | | | | | | | | | | | | | | | | | | | | | | | | | | | | | | | | | | | | | | | | | | | | | | | | | | | | | |
| (W) Width | MM (in.) | .50 ± .10 (.020 ± .004) | | 1.02 ± .25 (.040 ± .010) | | | .81 ± .15 (.032 ± .006) | | | 1.25 ± .20 (.049 ± .008) | | | | 1.60 ± .20 (.063 ± .008) | | | 1.27 ± .25 (.050 ± .010) | | | | | | | | | | | | | | | | | | | | | | | | | | | | | | | | | | | | | | | | | | | | | | | | | | | | | | | | | | | | | | | | | | | | | | | | | | | | | | | | | | | | | | | | | | | | | | | | | | | | | | | | | | | | | | | | | | | | | | | | | | | | | | | | | | | | | | | | | | | | | | | | | | | | | | | | | | | | | | | | | | | | | | | | | | | | | | | | | | | | | | | | | | | | | | | | | | | | | | | | | | | | | | | | | | | | | | | | | | | | | | | | | | | | | | | | | | | | | | | | | | | | | | | | | | | | | | | | | | | | | | | | | | | | | | | | | | | | | | | | | | | | | | | | | | | | | | | | | | | | | | | | | | | | | | | | | | | | | | | | | | | | | | | | | | | | | | | | | | | | | | | | | | | | | | | | | | | | | | | | | | | | | | | | | | | | | | | | | | | | | | | | | | | | | | | | | | | | | | | | | | | | | | | | | | | | | | | | | | | | | | | | | | | | | | | | | | | | | | | | | | | | | | | | | | | | | | | | | | | | | | | | | | | | | | | | | | | | | | | | | | | | | | | | | | | | | | | | | | | | | | | | | | | | | | | | | | | | | | | | | | | | | | | | | | | | | | | | | | | | | | | | | | | | | | | | | | | | | | | | | | | | | | | | | | | | | | | | | | | | | | | | | | | | | | | | | | | | | | | | | | | | | | | | | | | | | | | | | | | | | | | | | | | | | | | | | | | | | | | | | | | | | | | | | | | | | | | | | | | | | | | | | | | | | | | | | | | | | | | | | | | | | | | | | | | | | | | | | | | | | | | | | | | | | | | | | | | | | | | | | | | | | | | | | | | | | | | | | | | | | | | | | | | | | | | | | | | | | | | | | | | | | | | | | | | | | | | | | | | | | | | | | | | | | | | | | | | | | | | | | | | | | | | | | | | | | | | | | | | | | | | | | | | | | | | | | | | | | | | | | | | | | | | | | | | | | | | | | | | | | | | | | | | | | | | | | | | | | | | | | | | | | | | | | | | | | | | | | | | | | | | | | | | | | | | | | | | | | | | | | | | | | | | | | | | | | | | | | | | | | | | | | | | | | | | | | | | | | | | | | | | | | | | | | | | | | | | | | | | | | | | | | | | | | | | | | | | | | | | | | | | | | | | | | | | | | | | | | | | | | | | | | | | | | | | | | | | | | | | | | | | | | | | | | | | | | | |
| (T) Max. Thickness | MM (in.) | .60 (.024) | | 1.02 (.040) | | | .90 (.035) | | | 1.30 (.051) | | | | 1.50 (.059) | | | 1.27 (.050) | | | | | | | | | | | | | | | | | | | | | | | | | | | | | | | | | | | | | | | | | | | | | | | | | | | | | | | | | | | | | | | | | | | | | | | | | | | | | | | | | | | | | | | | | | | | | | | | | | | | | | | | | | | | | | | | | | | | | | | | | | | | | | | | | | | | | | | | | | | | | | | | | | | | | | | | | | | | | | | | | | | | | | | | | | | | | | | | | | | | | | | | | | | | | | | | | | | | | | | | | | | | | | | | | | | | | | | | | | | | | | | | | | | | | | | | | | | | | | | | | | | | | | | | | | | | | | | | | | | | | | | | | | | | | | | | | | | | | | | | | | | | | | | | | | | | | | | | | | | | | | | | | | | | | | | | | | | | | | | | | | | | | | | | | | | | | | | | | | | | | | | | | | | | | | | | | | | | | | | | | | | | | | | | | | | | | | | | | | | | | | | | | | | | | | | | | | | | | | | | | | | | | | | | | | | | | | | | | | | | | | | | | | | | | | | | | | | | | | | | | | | | | | | | | | | | | | | | | | | | | | | | | | | | | | | | | | | | | | | | | | | | | | | | | | | | | | | | | | | | | | | | | | | | | | | | | | | | | | | | | | | | | | | | | | | | | | | | | | | | | | | | | | | | | | | | | | | | | | | | | | | | | | | | | | | | | | | | | | | | | | | | | | | | | | | | | | | | | | | | | | | | | | | | | | | | | | | | | | | | | | | | | | | | | | | | | | | | | | | | | | | | | | | | | | | | | | | | | | | | | | | | | | | | | | | | | | | | | | | | | | | | | | | | | | | | | | | | | | | | | | | | | | | | | | | | | | | | | | | | | | | | | | | | | | | | | | | | | | | | | | | | | | | | | | | | | | | | | | | | | | | | | | | | | | | | | | | | | | | | | | | | | | | | | | | | | | | | | | | | | | | | | | | | | | | | | | | | | | | | | | | | | | | | | | | | | | | | | | | | | | | | | | | | | | | | | | | | | | | | | | | | | | | | | | | | | | | | | | | | | | | | | | | | | | | | | | | | | | | | | | | | | | | | | | | | | | | | | | | | | | | | | | | | | | | | | | | | | | | | | | | | | | | | | | | | | | | | | | | | | | | | | | | | | | | | | | | | | | | | | | | | | | | | | | | | | | | | | | | | | | | | | | | | | | | | | | | | | | | | | | | | | | | | | | | | | | | | | | | | | | | | | | | | | | | | | | |
| (t) Terminal | MM (in.) | .25 ± .15 (.010 ± .006) | | .38 ± .13 (.015 ± .005) | | | .35 ± .15 (.014 ± .006) | | | .50 ± .25 (.020 ± .010) | | | | .50 ± .25 (.020 ± .010) | | | .50 ± .25 (.020 ± .010) | | | | | | | | | | | | | | | | | | | | | | | | | | | | | | | | | | | | | | | | | | | | | | | | | | | | | | | | | | | | | | | | | | | | | | | | | | | | | | | | | | | | | | | | | | | | | | | | | | | | | | | | | | | | | | | | | | | | | | | | | | | | | | | | | | | | | | | | | | | | | | | | | | | | | | | | | | | | | | | | | | | | | | | | | | | | | | | | | | | | | | | | | | | | | | | | | | | | | | | | | | | | | | | | | | | | | | | | | | | | | | | | | | | | | | | | | | | | | | | | | | | | | | | | | | | | | | | | | | | | | | | | | | | | | | | | | | | | | | | | | | | | | | | | | | | | | | | | | | | | | | | | | | | | | | | | | | | | | | | | | | | | | | | | | | | | | | | | | | | | | | | | | | | | | | | | | | | | | | | | | | | | | | | | | | | | | | | | | | | | | | | | | | | | | | | | | | | | | | | | | | | | | | | | | | | | | | | | | | | | | | | | | | | | | | | | | | | | | | | | | | | | | | | | | | | | | | | | | | | | | | | | | | | | | | | | | | | | | | | | | | | | | | | | | | | | | | | | | | | | | | | | | | | | | | | | | | | | | | | | | | | | | | | | | | | | | | | | | | | | | | | | | | | | | | | | | | | | | | | | | | | | | | | | | | | | | | | | | | | | | | | | | | | | | | | | | | | | | | | | | | | | | | | | | | | | | | | | | | | | | | | | | | | | | | | | | | | | | | | | | | | | | | | | | | | | | | | | | | | | | | | | | | | | | | | | | | | | | | | | | | | | | | | | | | | | | | | | | | | | | | | | | | | | | | | | | | | | | | | | | | | | | | | | | | | | | | | | | | | | | | | | | | | | | | | | | | | | | | | | | | | | | | | | | | | | | | | | | | | | | | | | | | | | | | | | | | | | | | | | | | | | | | | | | | | | | | | | | | | | | | | | | | | | | | | | | | | | | | | | | | | | | | | | | | | | | | | | | | | | | | | | | | | | | | | | | | | | | | | | | | | | | | | | | | | | | | | | | | | | | | | | | | | | | | | | | | | | | | | | | | | | | | | | | | | | | | | | | | | | | | | | | | | | | | | | | | | | | | | | | | | | | | | | | | | | | | | | | | | | | | | | | | | | | | | | | | | | | | | | | | | | | | | | | | | | | | | | | | | | | | | | | | | | | | | | | | | | | | | | | | | | | | | | | | | | | | |
| WWDC | | 25 | 50 | 25 | 50 | 100 | 25 | 50 | 100 | 25 | 50 | 100 | 200 | 25 | 50 | 100 | 200 | 50 | 100 | 200 | | | | | | | | | | | | | | | | | | | | | | | | | | | | | | | | | | | | | | | | | | | | | | | | | | | | | | | | | | | | | | | | | | | | | | | | | | | | | | | | | | | | | | | | | | | | | | | | | | | | | | | | | | | | | | | | | | | | | | | | | | | | | | | | | | | | | | | | | | | | | | | | | | | | | | | | | | | | | | | | | | | | | | | | | | | | | | | | | | | | | | | | | | | | | | | | | | | | | | | | | | | | | | | | | | | | | | | | | | | | | | | | | | | | | | | | | | | | | | | | | | | | | | | | | | | | | | | | | | | | | | | | | | | | | | | | | | | | | | | | | | | | | | | | | | | | | | | | | | | | | | | | | | | | | | | | | | | | | | | | | | | | | | | | | | | | | | | | | | | | | | | | | | | | | | | | | | | | | | | | | | | | | | | | | | | | | | | | | | | | | | | | | | | | | | | | | | | | | | | | | | | | | | | | | | | | | | | | | | | | | | | | | | | | | | | | | | | | | | | | | | | | | | | | | | | | | | | | | | | | | | | | | | | | | | | | | | | | | | | | | | | | | | | | | | | | | | | | | | | | | | | | | | | | | | | | | | | | | | | | | | | | | | | | | | | | | | | | | | | | | | | | | | | | | | | | | | | | | | | | | | | | | | | | | | | | | | | | | | | | | | | | | | | | | | | | | | | | | | | | | | | | | | | | | | | | | | | | | | | | | | | | | | | | | | | | | | | | | | | | | | | | | | | | | | | | | | | | | | | | | | | | | | | | | | | | | | | | | | | | | | | | | | | | | | | | | | | | | | | | | | | | | | | | | | | | | | | | | | | | | | | | | | | | | | | | | | | | | | | | | | | | | | | | | | | | | | | | | | | | | | | | | | | | | | | | | | | | | | | | | | | | | | | | | | | | | | | | | | | | | | | | | | | | | | | | | | | | | | | | | | | | | | | | | | | | | | | | | | | | | | | | | | | | | | | | | | | | | | | | | | | | | | | | | | | | | | | | | | | | | | | | | | | | | | | | | | | | | | | | | | | | | | | | | | | | | | | | | | | | | | | | | | | | | | | | | | | | | | | | | | | | | | | | | | | | | | | | | | | | | | | | | | | | | | | | | | | | | | | | | | | | | | | | | | | | | | | | | | | | | | | | | | | | | | | | | | | | | | | | | | | | | | | | | | | | | | | | | | | | | | | | | | | | | | | |
| Cap (pF) | | | | | | | | | | | | | | | | | | | | | | | | | | | | | | | | | | | | | | | | | | | | | | | | | | | | | | | | | | | | | | | | | | | | | | | | | | | | | | | | | | | | | | | | | | | | | | | | | | | | | | | | | | | | | | | | | | | | | | | | | | | | | | | | | | | | | | | | | | | | | | | | | | | | | | | | | | | | | | | | | | | | | | | | | | | | | | | | | | | | | | | | | | | | | | | | | | | | | | | | | | | | | | | | | | | | | | | | | | | | | | | | | | | | | | | | | | | | | | | | | | | | | | | | | | | | | | | | | | | | | | | | | | | | | | | | | | | | | | | | | | | | | | | | | | | | | | | | | | | | | | | | | | | | | | | | | | | | | | | | | | | | | | | | | | | | | | | | | | | | | | | | | | | | | | | | | | | | | | | | | | | | | | | | | | | | | | | | | | | | | | | | | | | | | | | | | | | | | | | | | | | | | | | | | | | | | | | | | | | | | | | | | | | | | | | | | | | | | | | | | | | | | | | | | | | | | | | | | | | | | | | | | | | | | | | | | | | | | | | | | | | | | | | | | | | | | | | | | | | | | | | | | | | | | | | | | | | | | | | | | | | | | | | | | | | | | | | | | | | | | | | | | | | | | | | | | | | | | | | | | | | | | | | | | | | | | | | | | | | | | | | | | | | | | | | | | | | | | | | | | | | | | | | | | | | | | | | | | | | | | | | | | | | | | | | | | | | | | | | | | | | | | | | | | | | | | | | | | | | | | | | | | | | | | | | | | | | | | | | | | | | | | | | | | | | | | | | | | | | | | | | | | | | | | | | | | | | | | | | | | | | | | | | | | | | | | | | | | | | | | | | | | | | | | | | | | | | | | | | | | | | | | | | | | | | | | | | | | | | | | | | | | | | | | | | | | | | | | | | | | | | | | | | | | | | | | | | | | | | | | | | | | | | | | | | | | | | | | | | | | | | | | | | | | | | | | | | | | | | | | | | | | | | | | | | | | | | | | | | | | | | | | | | | | | | | | | | | | | | | | | | | | | | | | | | | | | | | | | | | | | | | | | | | | | | | | | | | | | | | | | | | | | | | | | | | | | | | | | | | | | | | | | | | | | | | | | | | | | | | | | | | | | | | | | | | | | | | | | | | | | | | | | | | | | | | | | | | | | | | | | | | | | | | | | | | | | | | | | | | | | | | | | | | | | | | | | | | | | | | | | | | | | | | | | | |
| | | <table border="1"> <tr><td>0.5</td><td></td><td></td><td></td><td></td><td></td><td></td><td></td><td></td><td></td><td></td><td></td><td></td><td></td><td></td><td></td><td></td><td></td><td></td><td></td><td></td></tr> <tr><td>1.0</td><td></td><td></td><td></td><td></td><td></td><td></td><td></td><td></td><td></td><td></td><td></td><td></td><td></td><td></td><td></td><td></td><td></td><td></td><td></td><td></td></tr> <tr><td>1.2</td><td></td><td></td><td></td><td></td><td></td><td></td><td></td><td></td><td></td><td></td><td></td><td></td><td></td><td></td><td></td><td></td><td></td><td></td><td></td><td></td></tr> <tr><td>1.5</td><td></td><td></td><td></td><td></td><td></td><td></td><td></td><td></td><td></td><td></td><td></td><td></td><td></td><td></td><td></td><td></td><td></td><td></td><td></td><td></td></tr> <tr><td>1.8</td><td></td><td></td><td></td><td></td><td></td><td></td><td></td><td></td><td></td><td></td><td></td><td></td><td></td><td></td><td></td><td></td><td></td><td></td><td></td><td></td></tr> <tr><td>2.2</td><td></td><td></td><td></td><td></td><td></td><td></td><td></td><td></td><td></td><td></td><td></td><td></td><td></td><td></td><td></td><td></td><td></td><td></td><td></td><td></td></tr> <tr><td>2.7</td><td></td><td></td><td></td><td></td><td></td><td></td><td></td><td></td><td></td><td></td><td></td><td></td><td></td><td></td><td></td><td></td><td></td><td></td><td></td><td></td></tr> <tr><td>3.3</td><td></td><td></td><td></td><td></td><td></td><td></td><td></td><td></td><td></td><td></td><td></td><td></td><td></td><td></td><td></td><td></td><td></td><td></td><td></td><td></td></tr> <tr><td>3.9</td><td></td><td></td><td></td><td></td><td></td><td></td><td></td><td></td><td></td><td></td><td></td><td></td><td></td><td></td><td></td><td></td><td></td><td></td><td></td><td></td></tr> <tr><td>4.7</td><td></td><td></td><td></td><td></td><td></td><td></td><td></td><td></td><td></td><td></td><td></td><td></td><td></td><td></td><td></td><td></td><td></td><td></td><td></td><td></td></tr> <tr><td>5.6</td><td></td><td></td><td></td><td></td><td></td><td></td><td></td><td></td><td></td><td></td><td></td><td></td><td></td><td></td><td></td><td></td><td></td><td></td><td></td><td></td></tr> <tr><td>6.8</td><td></td><td></td><td></td><td></td><td></td><td></td><td></td><td></td><td></td><td></td><td></td><td></td><td></td><td></td><td></td><td></td><td></td><td></td><td></td><td></td></tr> <tr><td>8.2</td><td></td><td></td><td></td><td></td><td></td><td></td><td></td><td></td><td></td><td></td><td></td><td></td><td></td><td></td><td></td><td></td><td></td><td></td><td></td><td></td></tr> <tr><td>10</td><td></td><td></td><td></td><td></td><td></td><td></td><td></td><td></td><td></td><td></td><td></td><td></td><td></td><td></td><td></td><td></td><td></td><td></td><td></td><td></td></tr> <tr><td>12</td><td></td><td></td><td></td><td></td><td></td><td></td><td></td><td></td><td></td><td></td><td></td><td></td><td></td><td></td><td></td><td></td><td></td><td></td><td></td><td></td></tr> <tr><td>15</td><td></td><td></td><td></td><td></td><td></td><td></td><td></td><td></td><td></td><td></td><td></td><td></td><td></td><td></td><td></td><td></td><td></td><td></td><td></td><td></td></tr> <tr><td>18</td><td></td><td></td><td></td><td></td><td></td><td></td><td></td><td></td><td></td><td></td><td></td><td></td><td></td><td></td><td></td><td></td><td></td><td></td><td></td><td></td></tr> <tr><td>22</td><td></td><td></td><td></td><td></td><td></td><td></td><td></td><td></td><td></td><td></td><td></td><td></td><td></td><td></td><td></td><td></td><td></td><td></td><td></td><td></td></tr> <tr><td>27</td><td></td><td></td><td></td><td></td><td></td><td></td><td></td><td></td><td></td><td></td><td></td><td></td><td></td><td></td><td></td><td></td><td></td><td></td><td></td><td></td></tr> <tr><td>33</td><td></td><td></td><td></td><td></td><td></td><td></td><td></td><td></td><td></td><td></td><td></td><td></td><td></td><td></td><td></td><td></td><td></td><td></td><td></td><td></td></tr> <tr><td>39</td><td></td><td></td><td></td><td></td><td></td><td></td><td></td><td></td><td></td><td></td><td></td><td></td><td></td><td></td><td></td><td></td><td></td><td></td><td></td><td></td></tr> <tr><td>47</td><td></td><td></td><td></td><td></td><td></td><td></td><td></td><td></td><td></td><td></td><td></td><td></td><td></td><td></td><td></td><td></td><td></td><td></td><td></td><td></td></tr> <tr><td>56</td><td></td><td></td><td></td><td></td><td></td><td></td><td></td><td></td><td></td><td></td><td></td><td></td><td></td><td></td><td></td><td></td><td></td><td></td><td></td><td></td></tr> <tr><td>68</td><td></td><td></td><td></td><td></td><td></td><td></td><td></td><td></td><td></td><td></td><td></td><td></td><td></td><td></td><td></td><td></td><td></td><td></td><td></td><td></td></tr> <tr><td>82</td><td></td><td></td><td></td><td></td><td></td><td></td><td></td><td></td><td></td><td></td><td></td><td></td><td></td><td></td><td></td><td></td><td></td><td></td><td></td><td></td></tr> <tr><td>100</td><td></td><td></td><td></td><td></td><td></td><td></td><td></td><td></td><td></td><td></td><td></td><td></td><td></td><td></td><td></td><td></td><td></td><td></td><td></td><td></td></tr> <tr><td>120</td><td></td><td></td><td></td><td></td><td></td><td></td><td></td><td></td><td></td><td></td><td></td><td></td><td></td><td></td><td></td><td></td><td></td><td></td><td></td><td></td></tr> <tr><td>150</td><td></td><td></td><td></td><td></td><td></td><td></td><td></td><td></td><td></td><td></td><td></td><td></td><td></td><td></td><td></td><td></td><td></td><td></td><td></td><td></td></tr> <tr><td>180</td><td></td><td></td><td></td><td></td><td></td><td></td><td></td><td></td><td></td><td></td><td></td><td></td><td></td><td></td><td></td><td></td><td></td><td></td><td></td><td></td></tr> <tr><td>220</td><td></td><td></td><td></td><td></td><td></td><td></td><td></td><td></td><td></td><td></td><td></td><td></td><td></td><td></td><td></td><td></td><td></td><td></td><td></td><td></td></tr> <tr><td>270</td><td></td><td></td><td></td><td></td><td></td><td></td><td></td><td></td><td></td><td></td><td></td><td></td><td></td><td></td><td></td><td></td><td></td><td></td><td></td><td></td></tr> <tr><td>330</td><td></td><td></td><td></td><td></td><td></td><td></td><td></td><td></td><td></td><td></td><td></td><td></td><td></td><td></td><td></td><td></td><td></td><td></td><td></td><td></td></tr> <tr><td>390</td><td></td><td></td><td></td><td></td><td></td><td></td><td></td><td></td><td></td><td></td><td></td><td></td><td></td><td></td><td></td><td></td><td></td><td></td><td></td><td></td></tr> <tr><td>470</td><td></td><td></td><td></td><td></td><td></td><td></td><td></td><td></td><td></td><td></td><td></td><td></td><td></td><td></td><td></td><td></td><td></td><td></td><td></td><td></td></tr> <tr><td>560</td><td></td><td></td><td></td><td></td><td></td><td></td><td></td><td></td><td></td><td></td><td></td><td></td><td></td><td></td><td></td><td></td><td></td><td></td><td></td><td></td></tr> <tr><td>680</td><td></td><td></td><td></td><td></td><td></td><td></td><td></td><td></td><td></td><td></td><td></td><td></td><td></td><td></td><td></td><td></td><td></td><td></td><td></td><td></td></tr> <tr><td>820</td><td></td><td></td><td></td><td></td><td></td><td></td><td></td><td></td><td></td><td></td><td></td><td></td><td></td><td></td><td></td><td></td><td></td><td></td><td></td><td></td></tr> <tr><td>1000</td><td></td><td></td><td></td><td></td><td></td><td></td><td></td><td></td><td></td><td></td><td></td><td></td><td></td><td></td><td></td><td></td><td></td><td></td><td></td><td></td></tr> <tr><td>1200</td><td></td><td></td><td></td><td></td><td></td><td></td><td></td><td></td><td></td><td></td><td></td><td></td><td></td><td></td><td></td><td></td><td></td><td></td><td></td><td></td></tr> <tr><td>1500</td><td></td><td></td><td></td><td></td><td></td><td></td><td></td><td></td><td></td><td></td><td></td><td></td><td></td><td></td><td></td><td></td><td></td><td></td><td></td><td></td></tr> <tr><td>1800</td><td></td><td></td><td></td><td></td><td></td><td></td><td></td><td></td><td></td><td></td><td></td><td></td><td></td><td></td><td></td><td></td><td></td><td></td><td></td><td></td></tr> <tr><td>2200</td><td></td><td></td><td></td><td></td><td></td><td></td><td></td><td></td><td></td><td></td><td></td><td></td><td></td><td></td><td></td><td></td><td></td><td></td><td></td><td></td></tr> <tr><td>2700</td><td></td><td></td><td></td><td></td><td></td><td></td><td></td><td></td><td></td><td></td><td></td><td></td><td></td><td></td><td></td><td></td><td></td><td></td><td></td><td></td></tr> <tr><td>3300</td><td></td><td></td><td></td><td></td><td></td><td></td><td></td><td></td><td></td><td></td><td></td><td></td><td></td><td></td><td></td><td></td><td></td><td></td><td></td><td></td></tr> <tr><td>3900</td><td></td><td></td><td></td><td></td><td></td><td></td><td></td><td></td><td></td><td></td><td></td><td></td><td></td><td></td><td></td><td></td><td></td><td></td><td></td><td></td></tr> <tr><td>4700</td><td></td><td></td><td></td><td></td><td></td><td></td><td></td><td></td><td></td><td></td><td></td><td></td><td></td><td></td><td></td><td></td><td></td><td></td><td></td><td></td></tr> <tr><td>5600</td><td></td><td></td><td></td><td></td><td></td><td></td><td></td><td></td><td></td><td></td><td></td><td></td><td></td><td></td><td></td><td></td><td></td><td></td><td></td><td></td></tr> <tr><td>6800</td><td></td><td></td><td></td><td></td><td></td><td></td><td></td><td></td><td></td><td></td><td></td><td></td><td></td><td></td><td></td><td></td><td></td><td></td><td></td><td></td></tr> <tr><td>8200</td><td></td><td></td><td></td><td></td><td></td><td></td><td></td><td></td><td></td><td></td><td></td><td></td><td></td><td></td><td></td><td></td><td></td><td></td><td></td><td></td></tr> <tr><td>10000</td><td></td><td></td><td></td><td></td><td></td><td></td><td></td><td></td><td></td><td></td><td></td><td></td><td></td><td></td><td></td><td></td><td></td><td></td><td></td><td></td></tr> </table> | | | | | | | | | | | | | | | | | | | | 0.5 | | | | | | | | | | | | | | | | | | | | | 1.0 | | | | | | | | | | | | | | | | | | | | | 1.2 | | | | | | | | | | | | | | | | | | | | | 1.5 | | | | | | | | | | | | | | | | | | | | | 1.8 | | | | | | | | | | | | | | | | | | | | | 2.2 | | | | | | | | | | | | | | | | | | | | | 2.7 | | | | | | | | | | | | | | | | | | | | | 3.3 | | | | | | | | | | | | | | | | | | | | | 3.9 | | | | | | | | | | | | | | | | | | | | | 4.7 | | | | | | | | | | | | | | | | | | | | | 5.6 | | | | | | | | | | | | | | | | | | | | | 6.8 | | | | | | | | | | | | | | | | | | | | | 8.2 | | | | | | | | | | | | | | | | | | | | | 10 | | | | | | | | | | | | | | | | | | | | | 12 | | | | | | | | | | | | | | | | | | | | | 15 | | | | | | | | | | | | | | | | | | | | | 18 | | | | | | | | | | | | | | | | | | | | | 22 | | | | | | | | | | | | | | | | | | | | | 27 | | | | | | | | | | | | | | | | | | | | | 33 | | | | | | | | | | | | | | | | | | | | | 39 | | | | | | | | | | | | | | | | | | | | | 47 | | | | | | | | | | | | | | | | | | | | | 56 | | | | | | | | | | | | | | | | | | | | | 68 | | | | | | | | | | | | | | | | | | | | | 82 | | | | | | | | | | | | | | | | | | | | | 100 | | | | | | | | | | | | | | | | | | | | | 120 | | | | | | | | | | | | | | | | | | | | | 150 | | | | | | | | | | | | | | | | | | | | | 180 | | | | | | | | | | | | | | | | | | | | | 220 | | | | | | | | | | | | | | | | | | | | | 270 | | | | | | | | | | | | | | | | | | | | | 330 | | | | | | | | | | | | | | | | | | | | | 390 | | | | | | | | | | | | | | | | | | | | | 470 | | | | | | | | | | | | | | | | | | | | | 560 | | | | | | | | | | | | | | | | | | | | | 680 | | | | | | | | | | | | | | | | | | | | | 820 | | | | | | | | | | | | | | | | | | | | | 1000 | | | | | | | | | | | | | | | | | | | | | 1200 | | | | | | | | | | | | | | | | | | | | | 1500 | | | | | | | | | | | | | | | | | | | | | 1800 | | | | | | | | | | | | | | | | | | | | | 2200 | | | | | | | | | | | | | | | | | | | | | 2700 | | | | | | | | | | | | | | | | | | | | | 3300 | | | | | | | | | | | | | | | | | | | | | 3900 | | | | | | | | | | | | | | | | | | | | | 4700 | | | | | | | | | | | | | | | | | | | | | 5600 | | | | | | | | | | | | | | | | | | | | | 6800 | | | | | | | | | | | | | | | | | | | | | 8200 | | | | | | | | | | | | | | | | | | | | | 10000 | | | | | | | | | | | | | | | | | | | | |
| 0.5 | | | | | | | | | | | | | | | | | | | | | | | | | | | | | | | | | | | | | | | | | | | | | | | | | | | | | | | | | | | | | | | | | | | | | | | | | | | | | | | | | | | | | | | | | | | | | | | | | | | | | | | | | | | | | | | | | | | | | | | | | | | | | | | | | | | | | | | | | | | | | | | | | | | | | | | | | | | | | | | | | | | | | | | | | | | | | | | | | | | | | | | | | | | | | | | | | | | | | | | | | | | | | | | | | | | | | | | | | | | | | | | | | | | | | | | | | | | | | | | | | | | | | | | | | | | | | | | | | | | | | | | | | | | | | | | | | | | | | | | | | | | | | | | | | | | | | | | | | | | | | | | | | | | | | | | | | | | | | | | | | | | | | | | | | | | | | | | | | | | | | | | | | | | | | | | | | | | | | | | | | | | | | | | | | | | | | | | | | | | | | | | | | | | | | | | | | | | | | | | | | | | | | | | | | | | | | | | | | | | | | | | | | | | | | | | | | | | | | | | | | | | | | | | | | | | | | | | | | | | | | | | | | | | | | | | | | | | | | | | | | | | | | | | | | | | | | | | | | | | | | | | | | | | | | | | | | | | | | | | | | | | | | | | | | | | | | | | | | | | | | | | | | | | | | | | | | | | | | | | | | | | | | | | | | | | | | | | | | | | | | | | | | | | | | | | | | | | | | | | | | | | | | | | | | | | | | | | | | | | | | | | | | | | | | | | | | | | | | | | | | | | | | | | | | | | | | | | | | | | | | | | | | | | | | | | | | | | | | | | | | | | | | | | | | | | | | | | | | | | | | | | | | | | | | | | | | | | | | | | | | | | | | | | | | | | | | | | | | | | | | | | | | | | | | | | | | | | | | | | | | | | | | | | | | | | | | | | | | | | | | | | | | | | | | | | | | | | | | | | | | | | | | | | | | | | | | | | | | | | | | | | | | | | | | | | | | | | | | | | | | | | | | | | | | | | | | | | | | | | | | | | | | | | | | | | | | | | | | | | | | | | | | | | | | | | | | | | | | | | | | | | | | | | | | | | | | | | | | | | | | | | | | | | | | | | | | | | | | | | | | | | | | | | | | | | | | | | | | | | | | | | | | | | | | | | | | | | | | | | | | | | | | | | | | | | | | | | | | | | | | | | | | | | | | | | | | | | | | | | | | | | | | | | | | | | | | | | | | | | | | | | | | | | | | | | | | | | | | | | | | | | | | | | | | | | |
| 1.0 | | | | | | | | | | | | | | | | | | | | | | | | | | | | | | | | | | | | | | | | | | | | | | | | | | | | | | | | | | | | | | | | | | | | | | | | | | | | | | | | | | | | | | | | | | | | | | | | | | | | | | | | | | | | | | | | | | | | | | | | | | | | | | | | | | | | | | | | | | | | | | | | | | | | | | | | | | | | | | | | | | | | | | | | | | | | | | | | | | | | | | | | | | | | | | | | | | | | | | | | | | | | | | | | | | | | | | | | | | | | | | | | | | | | | | | | | | | | | | | | | | | | | | | | | | | | | | | | | | | | | | | | | | | | | | | | | | | | | | | | | | | | | | | | | | | | | | | | | | | | | | | | | | | | | | | | | | | | | | | | | | | | | | | | | | | | | | | | | | | | | | | | | | | | | | | | | | | | | | | | | | | | | | | | | | | | | | | | | | | | | | | | | | | | | | | | | | | | | | | | | | | | | | | | | | | | | | | | | | | | | | | | | | | | | | | | | | | | | | | | | | | | | | | | | | | | | | | | | | | | | | | | | | | | | | | | | | | | | | | | | | | | | | | | | | | | | | | | | | | | | | | | | | | | | | | | | | | | | | | | | | | | | | | | | | | | | | | | | | | | | | | | | | | | | | | | | | | | | | | | | | | | | | | | | | | | | | | | | | | | | | | | | | | | | | | | | | | | | | | | | | | | | | | | | | | | | | | | | | | | | | | | | | | | | | | | | | | | | | | | | | | | | | | | | | | | | | | | | | | | | | | | | | | | | | | | | | | | | | | | | | | | | | | | | | | | | | | | | | | | | | | | | | | | | | | | | | | | | | | | | | | | | | | | | | | | | | | | | | | | | | | | | | | | | | | | | | | | | | | | | | | | | | | | | | | | | | | | | | | | | | | | | | | | | | | | | | | | | | | | | | | | | | | | | | | | | | | | | | | | | | | | | | | | | | | | | | | | | | | | | | | | | | | | | | | | | | | | | | | | | | | | | | | | | | | | | | | | | | | | | | | | | | | | | | | | | | | | | | | | | | | | | | | | | | | | | | | | | | | | | | | | | | | | | | | | | | | | | | | | | | | | | | | | | | | | | | | | | | | | | | | | | | | | | | | | | | | | | | | | | | | | | | | | | | | | | | | | | | | | | | | | | | | | | | | | | | | | | | | | | | | | | | | | | | | | | | | | | | | | | | | | | | | | | | | | | | | | | | | | | | | | | | | | | | | |
| 1.2 | | | | | | | | | | | | | | | | | | | | | | | | | | | | | | | | | | | | | | | | | | | | | | | | | | | | | | | | | | | | | | | | | | | | | | | | | | | | | | | | | | | | | | | | | | | | | | | | | | | | | | | | | | | | | | | | | | | | | | | | | | | | | | | | | | | | | | | | | | | | | | | | | | | | | | | | | | | | | | | | | | | | | | | | | | | | | | | | | | | | | | | | | | | | | | | | | | | | | | | | | | | | | | | | | | | | | | | | | | | | | | | | | | | | | | | | | | | | | | | | | | | | | | | | | | | | | | | | | | | | | | | | | | | | | | | | | | | | | | | | | | | | | | | | | | | | | | | | | | | | | | | | | | | | | | | | | | | | | | | | | | | | | | | | | | | | | | | | | | | | | | | | | | | | | | | | | | | | | | | | | | | | | | | | | | | | | | | | | | | | | | | | | | | | | | | | | | | | | | | | | | | | | | | | | | | | | | | | | | | | | | | | | | | | | | | | | | | | | | | | | | | | | | | | | | | | | | | | | | | | | | | | | | | | | | | | | | | | | | | | | | | | | | | | | | | | | | | | | | | | | | | | | | | | | | | | | | | | | | | | | | | | | | | | | | | | | | | | | | | | | | | | | | | | | | | | | | | | | | | | | | | | | | | | | | | | | | | | | | | | | | | | | | | | | | | | | | | | | | | | | | | | | | | | | | | | | | | | | | | | | | | | | | | | | | | | | | | | | | | | | | | | | | | | | | | | | | | | | | | | | | | | | | | | | | | | | | | | | | | | | | | | | | | | | | | | | | | | | | | | | | | | | | | | | | | | | | | | | | | | | | | | | | | | | | | | | | | | | | | | | | | | | | | | | | | | | | | | | | | | | | | | | | | | | | | | | | | | | | | | | | | | | | | | | | | | | | | | | | | | | | | | | | | | | | | | | | | | | | | | | | | | | | | | | | | | | | | | | | | | | | | | | | | | | | | | | | | | | | | | | | | | | | | | | | | | | | | | | | | | | | | | | | | | | | | | | | | | | | | | | | | | | | | | | | | | | | | | | | | | | | | | | | | | | | | | | | | | | | | | | | | | | | | | | | | | | | | | | | | | | | | | | | | | | | | | | | | | | | | | | | | | | | | | | | | | | | | | | | | | | | | | | | | | | | | | | | | | | | | | | | | | | | | | | | | | | | | | | | | | | | | | | | | | | | | | | | | | | | | | | | | | | | | | | | | |
| 1.5 | | | | | | | | | | | | | | | | | | | | | | | | | | | | | | | | | | | | | | | | | | | | | | | | | | | | | | | | | | | | | | | | | | | | | | | | | | | | | | | | | | | | | | | | | | | | | | | | | | | | | | | | | | | | | | | | | | | | | | | | | | | | | | | | | | | | | | | | | | | | | | | | | | | | | | | | | | | | | | | | | | | | | | | | | | | | | | | | | | | | | | | | | | | | | | | | | | | | | | | | | | | | | | | | | | | | | | | | | | | | | | | | | | | | | | | | | | | | | | | | | | | | | | | | | | | | | | | | | | | | | | | | | | | | | | | | | | | | | | | | | | | | | | | | | | | | | | | | | | | | | | | | | | | | | | | | | | | | | | | | | | | | | | | | | | | | | | | | | | | | | | | | | | | | | | | | | | | | | | | | | | | | | | | | | | | | | | | | | | | | | | | | | | | | | | | | | | | | | | | | | | | | | | | | | | | | | | | | | | | | | | | | | | | | | | | | | | | | | | | | | | | | | | | | | | | | | | | | | | | | | | | | | | | | | | | | | | | | | | | | | | | | | | | | | | | | | | | | | | | | | | | | | | | | | | | | | | | | | | | | | | | | | | | | | | | | | | | | | | | | | | | | | | | | | | | | | | | | | | | | | | | | | | | | | | | | | | | | | | | | | | | | | | | | | | | | | | | | | | | | | | | | | | | | | | | | | | | | | | | | | | | | | | | | | | | | | | | | | | | | | | | | | | | | | | | | | | | | | | | | | | | | | | | | | | | | | | | | | | | | | | | | | | | | | | | | | | | | | | | | | | | | | | | | | | | | | | | | | | | | | | | | | | | | | | | | | | | | | | | | | | | | | | | | | | | | | | | | | | | | | | | | | | | | | | | | | | | | | | | | | | | | | | | | | | | | | | | | | | | | | | | | | | | | | | | | | | | | | | | | | | | | | | | | | | | | | | | | | | | | | | | | | | | | | | | | | | | | | | | | | | | | | | | | | | | | | | | | | | | | | | | | | | | | | | | | | | | | | | | | | | | | | | | | | | | | | | | | | | | | | | | | | | | | | | | | | | | | | | | | | | | | | | | | | | | | | | | | | | | | | | | | | | | | | | | | | | | | | | | | | | | | | | | | | | | | | | | | | | | | | | | | | | | | | | | | | | | | | | | | | | | | | | | | | | | | | | | | | | | | | | | | | | | | | | | | | | | | | | | | | | | | | | | | | | | |
| 1.8 | | | | | | | | | | | | | | | | | | | | | | | | | | | | | | | | | | | | | | | | | | | | | | | | | | | | | | | | | | | | | | | | | | | | | | | | | | | | | | | | | | | | | | | | | | | | | | | | | | | | | | | | | | | | | | | | | | | | | | | | | | | | | | | | | | | | | | | | | | | | | | | | | | | | | | | | | | | | | | | | | | | | | | | | | | | | | | | | | | | | | | | | | | | | | | | | | | | | | | | | | | | | | | | | | | | | | | | | | | | | | | | | | | | | | | | | | | | | | | | | | | | | | | | | | | | | | | | | | | | | | | | | | | | | | | | | | | | | | | | | | | | | | | | | | | | | | | | | | | | | | | | | | | | | | | | | | | | | | | | | | | | | | | | | | | | | | | | | | | | | | | | | | | | | | | | | | | | | | | | | | | | | | | | | | | | | | | | | | | | | | | | | | | | | | | | | | | | | | | | | | | | | | | | | | | | | | | | | | | | | | | | | | | | | | | | | | | | | | | | | | | | | | | | | | | | | | | | | | | | | | | | | | | | | | | | | | | | | | | | | | | | | | | | | | | | | | | | | | | | | | | | | | | | | | | | | | | | | | | | | | | | | | | | | | | | | | | | | | | | | | | | | | | | | | | | | | | | | | | | | | | | | | | | | | | | | | | | | | | | | | | | | | | | | | | | | | | | | | | | | | | | | | | | | | | | | | | | | | | | | | | | | | | | | | | | | | | | | | | | | | | | | | | | | | | | | | | | | | | | | | | | | | | | | | | | | | | | | | | | | | | | | | | | | | | | | | | | | | | | | | | | | | | | | | | | | | | | | | | | | | | | | | | | | | | | | | | | | | | | | | | | | | | | | | | | | | | | | | | | | | | | | | | | | | | | | | | | | | | | | | | | | | | | | | | | | | | | | | | | | | | | | | | | | | | | | | | | | | | | | | | | | | | | | | | | | | | | | | | | | | | | | | | | | | | | | | | | | | | | | | | | | | | | | | | | | | | | | | | | | | | | | | | | | | | | | | | | | | | | | | | | | | | | | | | | | | | | | | | | | | | | | | | | | | | | | | | | | | | | | | | | | | | | | | | | | | | | | | | | | | | | | | | | | | | | | | | | | | | | | | | | | | | | | | | | | | | | | | | | | | | | | | | | | | | | | | | | | | | | | | | | | | | | | | | | | | | | | | | | | | | | | | | | | | | | | | | | | | | | | | | | | | | | | | | | |
| 2.2 | | | | | | | | | | | | | | | | | | | | | | | | | | | | | | | | | | | | | | | | | | | | | | | | | | | | | | | | | | | | | | | | | | | | | | | | | | | | | | | | | | | | | | | | | | | | | | | | | | | | | | | | | | | | | | | | | | | | | | | | | | | | | | | | | | | | | | | | | | | | | | | | | | | | | | | | | | | | | | | | | | | | | | | | | | | | | | | | | | | | | | | | | | | | | | | | | | | | | | | | | | | | | | | | | | | | | | | | | | | | | | | | | | | | | | | | | | | | | | | | | | | | | | | | | | | | | | | | | | | | | | | | | | | | | | | | | | | | | | | | | | | | | | | | | | | | | | | | | | | | | | | | | | | | | | | | | | | | | | | | | | | | | | | | | | | | | | | | | | | | | | | | | | | | | | | | | | | | | | | | | | | | | | | | | | | | | | | | | | | | | | | | | | | | | | | | | | | | | | | | | | | | | | | | | | | | | | | | | | | | | | | | | | | | | | | | | | | | | | | | | | | | | | | | | | | | | | | | | | | | | | | | | | | | | | | | | | | | | | | | | | | | | | | | | | | | | | | | | | | | | | | | | | | | | | | | | | | | | | | | | | | | | | | | | | | | | | | | | | | | | | | | | | | | | | | | | | | | | | | | | | | | | | | | | | | | | | | | | | | | | | | | | | | | | | | | | | | | | | | | | | | | | | | | | | | | | | | | | | | | | | | | | | | | | | | | | | | | | | | | | | | | | | | | | | | | | | | | | | | | | | | | | | | | | | | | | | | | | | | | | | | | | | | | | | | | | | | | | | | | | | | | | | | | | | | | | | | | | | | | | | | | | | | | | | | | | | | | | | | | | | | | | | | | | | | | | | | | | | | | | | | | | | | | | | | | | | | | | | | | | | | | | | | | | | | | | | | | | | | | | | | | | | | | | | | | | | | | | | | | | | | | | | | | | | | | | | | | | | | | | | | | | | | | | | | | | | | | | | | | | | | | | | | | | | | | | | | | | | | | | | | | | | | | | | | | | | | | | | | | | | | | | | | | | | | | | | | | | | | | | | | | | | | | | | | | | | | | | | | | | | | | | | | | | | | | | | | | | | | | | | | | | | | | | | | | | | | | | | | | | | | | | | | | | | | | | | | | | | | | | | | | | | | | | | | | | | | | | | | | | | | | | | | | | | | | | | | | | | | | | | | | | | | | | | | | | | | | | | | | | | | | | | | | | | | |
| 2.7 | | | | | | | | | | | | | | | | | | | | | | | | | | | | | | | | | | | | | | | | | | | | | | | | | | | | | | | | | | | | | | | | | | | | | | | | | | | | | | | | | | | | | | | | | | | | | | | | | | | | | | | | | | | | | | | | | | | | | | | | | | | | | | | | | | | | | | | | | | | | | | | | | | | | | | | | | | | | | | | | | | | | | | | | | | | | | | | | | | | | | | | | | | | | | | | | | | | | | | | | | | | | | | | | | | | | | | | | | | | | | | | | | | | | | | | | | | | | | | | | | | | | | | | | | | | | | | | | | | | | | | | | | | | | | | | | | | | | | | | | | | | | | | | | | | | | | | | | | | | | | | | | | | | | | | | | | | | | | | | | | | | | | | | | | | | | | | | | | | | | | | | | | | | | | | | | | | | | | | | | | | | | | | | | | | | | | | | | | | | | | | | | | | | | | | | | | | | | | | | | | | | | | | | | | | | | | | | | | | | | | | | | | | | | | | | | | | | | | | | | | | | | | | | | | | | | | | | | | | | | | | | | | | | | | | | | | | | | | | | | | | | | | | | | | | | | | | | | | | | | | | | | | | | | | | | | | | | | | | | | | | | | | | | | | | | | | | | | | | | | | | | | | | | | | | | | | | | | | | | | | | | | | | | | | | | | | | | | | | | | | | | | | | | | | | | | | | | | | | | | | | | | | | | | | | | | | | | | | | | | | | | | | | | | | | | | | | | | | | | | | | | | | | | | | | | | | | | | | | | | | | | | | | | | | | | | | | | | | | | | | | | | | | | | | | | | | | | | | | | | | | | | | | | | | | | | | | | | | | | | | | | | | | | | | | | | | | | | | | | | | | | | | | | | | | | | | | | | | | | | | | | | | | | | | | | | | | | | | | | | | | | | | | | | | | | | | | | | | | | | | | | | | | | | | | | | | | | | | | | | | | | | | | | | | | | | | | | | | | | | | | | | | | | | | | | | | | | | | | | | | | | | | | | | | | | | | | | | | | | | | | | | | | | | | | | | | | | | | | | | | | | | | | | | | | | | | | | | | | | | | | | | | | | | | | | | | | | | | | | | | | | | | | | | | | | | | | | | | | | | | | | | | | | | | | | | | | | | | | | | | | | | | | | | | | | | | | | | | | | | | | | | | | | | | | | | | | | | | | | | | | | | | | | | | | | | | | | | | | | | | | | | | | | | | | | | | | | | | | | | | | | | | | | | | | | |
| 3.3 | | | | | | | | | | | | | | | | | | | | | | | | | | | | | | | | | | | | | | | | | | | | | | | | | | | | | | | | | | | | | | | | | | | | | | | | | | | | | | | | | | | | | | | | | | | | | | | | | | | | | | | | | | | | | | | | | | | | | | | | | | | | | | | | | | | | | | | | | | | | | | | | | | | | | | | | | | | | | | | | | | | | | | | | | | | | | | | | | | | | | | | | | | | | | | | | | | | | | | | | | | | | | | | | | | | | | | | | | | | | | | | | | | | | | | | | | | | | | | | | | | | | | | | | | | | | | | | | | | | | | | | | | | | | | | | | | | | | | | | | | | | | | | | | | | | | | | | | | | | | | | | | | | | | | | | | | | | | | | | | | | | | | | | | | | | | | | | | | | | | | | | | | | | | | | | | | | | | | | | | | | | | | | | | | | | | | | | | | | | | | | | | | | | | | | | | | | | | | | | | | | | | | | | | | | | | | | | | | | | | | | | | | | | | | | | | | | | | | | | | | | | | | | | | | | | | | | | | | | | | | | | | | | | | | | | | | | | | | | | | | | | | | | | | | | | | | | | | | | | | | | | | | | | | | | | | | | | | | | | | | | | | | | | | | | | | | | | | | | | | | | | | | | | | | | | | | | | | | | | | | | | | | | | | | | | | | | | | | | | | | | | | | | | | | | | | | | | | | | | | | | | | | | | | | | | | | | | | | | | | | | | | | | | | | | | | | | | | | | | | | | | | | | | | | | | | | | | | | | | | | | | | | | | | | | | | | | | | | | | | | | | | | | | | | | | | | | | | | | | | | | | | | | | | | | | | | | | | | | | | | | | | | | | | | | | | | | | | | | | | | | | | | | | | | | | | | | | | | | | | | | | | | | | | | | | | | | | | | | | | | | | | | | | | | | | | | | | | | | | | | | | | | | | | | | | | | | | | | | | | | | | | | | | | | | | | | | | | | | | | | | | | | | | | | | | | | | | | | | | | | | | | | | | | | | | | | | | | | | | | | | | | | | | | | | | | | | | | | | | | | | | | | | | | | | | | | | | | | | | | | | | | | | | | | | | | | | | | | | | | | | | | | | | | | | | | | | | | | | | | | | | | | | | | | | | | | | | | | | | | | | | | | | | | | | | | | | | | | | | | | | | | | | | | | | | | | | | | | | | | | | | | | | | | | | | | | | | | | | | | | | | | | | | | | | | | | | | | | | | | | | | | | | | | | | | |
| 3.9 | | | | | | | | | | | | | | | | | | | | | | | | | | | | | | | | | | | | | | | | | | | | | | | | | | | | | | | | | | | | | | | | | | | | | | | | | | | | | | | | | | | | | | | | | | | | | | | | | | | | | | | | | | | | | | | | | | | | | | | | | | | | | | | | | | | | | | | | | | | | | | | | | | | | | | | | | | | | | | | | | | | | | | | | | | | | | | | | | | | | | | | | | | | | | | | | | | | | | | | | | | | | | | | | | | | | | | | | | | | | | | | | | | | | | | | | | | | | | | | | | | | | | | | | | | | | | | | | | | | | | | | | | | | | | | | | | | | | | | | | | | | | | | | | | | | | | | | | | | | | | | | | | | | | | | | | | | | | | | | | | | | | | | | | | | | | | | | | | | | | | | | | | | | | | | | | | | | | | | | | | | | | | | | | | | | | | | | | | | | | | | | | | | | | | | | | | | | | | | | | | | | | | | | | | | | | | | | | | | | | | | | | | | | | | | | | | | | | | | | | | | | | | | | | | | | | | | | | | | | | | | | | | | | | | | | | | | | | | | | | | | | | | | | | | | | | | | | | | | | | | | | | | | | | | | | | | | | | | | | | | | | | | | | | | | | | | | | | | | | | | | | | | | | | | | | | | | | | | | | | | | | | | | | | | | | | | | | | | | | | | | | | | | | | | | | | | | | | | | | | | | | | | | | | | | | | | | | | | | | | | | | | | | | | | | | | | | | | | | | | | | | | | | | | | | | | | | | | | | | | | | | | | | | | | | | | | | | | | | | | | | | | | | | | | | | | | | | | | | | | | | | | | | | | | | | | | | | | | | | | | | | | | | | | | | | | | | | | | | | | | | | | | | | | | | | | | | | | | | | | | | | | | | | | | | | | | | | | | | | | | | | | | | | | | | | | | | | | | | | | | | | | | | | | | | | | | | | | | | | | | | | | | | | | | | | | | | | | | | | | | | | | | | | | | | | | | | | | | | | | | | | | | | | | | | | | | | | | | | | | | | | | | | | | | | | | | | | | | | | | | | | | | | | | | | | | | | | | | | | | | | | | | | | | | | | | | | | | | | | | | | | | | | | | | | | | | | | | | | | | | | | | | | | | | | | | | | | | | | | | | | | | | | | | | | | | | | | | | | | | | | | | | | | | | | | | | | | | | | | | | | | | | | | | | | | | | | | | | | | | | | | | | | | | | | | | | | | | | | | | | | | | | | | | | | | |
| 4.7 | | | | | | | | | | | | | | | | | | | | | | | | | | | | | | | | | | | | | | | | | | | | | | | | | | | | | | | | | | | | | | | | | | | | | | | | | | | | | | | | | | | | | | | | | | | | | | | | | | | | | | | | | | | | | | | | | | | | | | | | | | | | | | | | | | | | | | | | | | | | | | | | | | | | | | | | | | | | | | | | | | | | | | | | | | | | | | | | | | | | | | | | | | | | | | | | | | | | | | | | | | | | | | | | | | | | | | | | | | | | | | | | | | | | | | | | | | | | | | | | | | | | | | | | | | | | | | | | | | | | | | | | | | | | | | | | | | | | | | | | | | | | | | | | | | | | | | | | | | | | | | | | | | | | | | | | | | | | | | | | | | | | | | | | | | | | | | | | | | | | | | | | | | | | | | | | | | | | | | | | | | | | | | | | | | | | | | | | | | | | | | | | | | | | | | | | | | | | | | | | | | | | | | | | | | | | | | | | | | | | | | | | | | | | | | | | | | | | | | | | | | | | | | | | | | | | | | | | | | | | | | | | | | | | | | | | | | | | | | | | | | | | | | | | | | | | | | | | | | | | | | | | | | | | | | | | | | | | | | | | | | | | | | | | | | | | | | | | | | | | | | | | | | | | | | | | | | | | | | | | | | | | | | | | | | | | | | | | | | | | | | | | | | | | | | | | | | | | | | | | | | | | | | | | | | | | | | | | | | | | | | | | | | | | | | | | | | | | | | | | | | | | | | | | | | | | | | | | | | | | | | | | | | | | | | | | | | | | | | | | | | | | | | | | | | | | | | | | | | | | | | | | | | | | | | | | | | | | | | | | | | | | | | | | | | | | | | | | | | | | | | | | | | | | | | | | | | | | | | | | | | | | | | | | | | | | | | | | | | | | | | | | | | | | | | | | | | | | | | | | | | | | | | | | | | | | | | | | | | | | | | | | | | | | | | | | | | | | | | | | | | | | | | | | | | | | | | | | | | | | | | | | | | | | | | | | | | | | | | | | | | | | | | | | | | | | | | | | | | | | | | | | | | | | | | | | | | | | | | | | | | | | | | | | | | | | | | | | | | | | | | | | | | | | | | | | | | | | | | | | | | | | | | | | | | | | | | | | | | | | | | | | | | | | | | | | | | | | | | | | | | | | | | | | | | | | | | | | | | | | | | | | | | | | | | | | | | | | | | | | | | | | | | | | | | | | | | | | | | | | | | | | | | | | | | | |
| 5.6 | | | | | | | | | | | | | | | | | | | | | | | | | | | | | | | | | | | | | | | | | | | | | | | | | | | | | | | | | | | | | | | | | | | | | | | | | | | | | | | | | | | | | | | | | | | | | | | | | | | | | | | | | | | | | | | | | | | | | | | | | | | | | | | | | | | | | | | | | | | | | | | | | | | | | | | | | | | | | | | | | | | | | | | | | | | | | | | | | | | | | | | | | | | | | | | | | | | | | | | | | | | | | | | | | | | | | | | | | | | | | | | | | | | | | | | | | | | | | | | | | | | | | | | | | | | | | | | | | | | | | | | | | | | | | | | | | | | | | | | | | | | | | | | | | | | | | | | | | | | | | | | | | | | | | | | | | | | | | | | | | | | | | | | | | | | | | | | | | | | | | | | | | | | | | | | | | | | | | | | | | | | | | | | | | | | | | | | | | | | | | | | | | | | | | | | | | | | | | | | | | | | | | | | | | | | | | | | | | | | | | | | | | | | | | | | | | | | | | | | | | | | | | | | | | | | | | | | | | | | | | | | | | | | | | | | | | | | | | | | | | | | | | | | | | | | | | | | | | | | | | | | | | | | | | | | | | | | | | | | | | | | | | | | | | | | | | | | | | | | | | | | | | | | | | | | | | | | | | | | | | | | | | | | | | | | | | | | | | | | | | | | | | | | | | | | | | | | | | | | | | | | | | | | | | | | | | | | | | | | | | | | | | | | | | | | | | | | | | | | | | | | | | | | | | | | | | | | | | | | | | | | | | | | | | | | | | | | | | | | | | | | | | | | | | | | | | | | | | | | | | | | | | | | | | | | | | | | | | | | | | | | | | | | | | | | | | | | | | | | | | | | | | | | | | | | | | | | | | | | | | | | | | | | | | | | | | | | | | | | | | | | | | | | | | | | | | | | | | | | | | | | | | | | | | | | | | | | | | | | | | | | | | | | | | | | | | | | | | | | | | | | | | | | | | | | | | | | | | | | | | | | | | | | | | | | | | | | | | | | | | | | | | | | | | | | | | | | | | | | | | | | | | | | | | | | | | | | | | | | | | | | | | | | | | | | | | | | | | | | | | | | | | | | | | | | | | | | | | | | | | | | | | | | | | | | | | | | | | | | | | | | | | | | | | | | | | | | | | | | | | | | | | | | | | | | | | | | | | | | | | | | | | | | | | | | | | | | | | | | | | | | | | | | | | | | | | | | | | | | | | | | | | | | | | | | |
| 6.8 | | | | | | | | | | | | | | | | | | | | | | | | | | | | | | | | | | | | | | | | | | | | | | | | | | | | | | | | | | | | | | | | | | | | | | | | | | | | | | | | | | | | | | | | | | | | | | | | | | | | | | | | | | | | | | | | | | | | | | | | | | | | | | | | | | | | | | | | | | | | | | | | | | | | | | | | | | | | | | | | | | | | | | | | | | | | | | | | | | | | | | | | | | | | | | | | | | | | | | | | | | | | | | | | | | | | | | | | | | | | | | | | | | | | | | | | | | | | | | | | | | | | | | | | | | | | | | | | | | | | | | | | | | | | | | | | | | | | | | | | | | | | | | | | | | | | | | | | | | | | | | | | | | | | | | | | | | | | | | | | | | | | | | | | | | | | | | | | | | | | | | | | | | | | | | | | | | | | | | | | | | | | | | | | | | | | | | | | | | | | | | | | | | | | | | | | | | | | | | | | | | | | | | | | | | | | | | | | | | | | | | | | | | | | | | | | | | | | | | | | | | | | | | | | | | | | | | | | | | | | | | | | | | | | | | | | | | | | | | | | | | | | | | | | | | | | | | | | | | | | | | | | | | | | | | | | | | | | | | | | | | | | | | | | | | | | | | | | | | | | | | | | | | | | | | | | | | | | | | | | | | | | | | | | | | | | | | | | | | | | | | | | | | | | | | | | | | | | | | | | | | | | | | | | | | | | | | | | | | | | | | | | | | | | | | | | | | | | | | | | | | | | | | | | | | | | | | | | | | | | | | | | | | | | | | | | | | | | | | | | | | | | | | | | | | | | | | | | | | | | | | | | | | | | | | | | | | | | | | | | | | | | | | | | | | | | | | | | | | | | | | | | | | | | | | | | | | | | | | | | | | | | | | | | | | | | | | | | | | | | | | | | | | | | | | | | | | | | | | | | | | | | | | | | | | | | | | | | | | | | | | | | | | | | | | | | | | | | | | | | | | | | | | | | | | | | | | | | | | | | | | | | | | | | | | | | | | | | | | | | | | | | | | | | | | | | | | | | | | | | | | | | | | | | | | | | | | | | | | | | | | | | | | | | | | | | | | | | | | | | | | | | | | | | | | | | | | | | | | | | | | | | | | | | | | | | | | | | | | | | | | | | | | | | | | | | | | | | | | | | | | | | | | | | | | | | | | | | | | | | | | | | | | | | | | | | | | | | | | | | | | | | | | | | | | | | | | | | | | | | | | | | | | | | | | | |
| 8.2 | | | | | | | | | | | | | | | | | | | | | | | | | | | | | | | | | | | | | | | | | | | | | | | | | | | | | | | | | | | | | | | | | | | | | | | | | | | | | | | | | | | | | | | | | | | | | | | | | | | | | | | | | | | | | | | | | | | | | | | | | | | | | | | | | | | | | | | | | | | | | | | | | | | | | | | | | | | | | | | | | | | | | | | | | | | | | | | | | | | | | | | | | | | | | | | | | | | | | | | | | | | | | | | | | | | | | | | | | | | | | | | | | | | | | | | | | | | | | | | | | | | | | | | | | | | | | | | | | | | | | | | | | | | | | | | | | | | | | | | | | | | | | | | | | | | | | | | | | | | | | | | | | | | | | | | | | | | | | | | | | | | | | | | | | | | | | | | | | | | | | | | | | | | | | | | | | | | | | | | | | | | | | | | | | | | | | | | | | | | | | | | | | | | | | | | | | | | | | | | | | | | | | | | | | | | | | | | | | | | | | | | | | | | | | | | | | | | | | | | | | | | | | | | | | | | | | | | | | | | | | | | | | | | | | | | | | | | | | | | | | | | | | | | | | | | | | | | | | | | | | | | | | | | | | | | | | | | | | | | | | | | | | | | | | | | | | | | | | | | | | | | | | | | | | | | | | | | | | | | | | | | | | | | | | | | | | | | | | | | | | | | | | | | | | | | | | | | | | | | | | | | | | | | | | | | | | | | | | | | | | | | | | | | | | | | | | | | | | | | | | | | | | | | | | | | | | | | | | | | | | | | | | | | | | | | | | | | | | | | | | | | | | | | | | | | | | | | | | | | | | | | | | | | | | | | | | | | | | | | | | | | | | | | | | | | | | | | | | | | | | | | | | | | | | | | | | | | | | | | | | | | | | | | | | | | | | | | | | | | | | | | | | | | | | | | | | | | | | | | | | | | | | | | | | | | | | | | | | | | | | | | | | | | | | | | | | | | | | | | | | | | | | | | | | | | | | | | | | | | | | | | | | | | | | | | | | | | | | | | | | | | | | | | | | | | | | | | | | | | | | | | | | | | | | | | | | | | | | | | | | | | | | | | | | | | | | | | | | | | | | | | | | | | | | | | | | | | | | | | | | | | | | | | | | | | | | | | | | | | | | | | | | | | | | | | | | | | | | | | | | | | | | | | | | | | | | | | | | | | | | | | | | | | | | | | | | | | | | | | | | | | | | | | | | | | | | | | | | | | | | | | | | | | | | | | |
| 10 | | | | | | | | | | | | | | | | | | | | | | | | | | | | | | | | | | | | | | | | | | | | | | | | | | | | | | | | | | | | | | | | | | | | | | | | | | | | | | | | | | | | | | | | | | | | | | | | | | | | | | | | | | | | | | | | | | | | | | | | | | | | | | | | | | | | | | | | | | | | | | | | | | | | | | | | | | | | | | | | | | | | | | | | | | | | | | | | | | | | | | | | | | | | | | | | | | | | | | | | | | | | | | | | | | | | | | | | | | | | | | | | | | | | | | | | | | | | | | | | | | | | | | | | | | | | | | | | | | | | | | | | | | | | | | | | | | | | | | | | | | | | | | | | | | | | | | | | | | | | | | | | | | | | | | | | | | | | | | | | | | | | | | | | | | | | | | | | | | | | | | | | | | | | | | | | | | | | | | | | | | | | | | | | | | | | | | | | | | | | | | | | | | | | | | | | | | | | | | | | | | | | | | | | | | | | | | | | | | | | | | | | | | | | | | | | | | | | | | | | | | | | | | | | | | | | | | | | | | | | | | | | | | | | | | | | | | | | | | | | | | | | | | | | | | | | | | | | | | | | | | | | | | | | | | | | | | | | | | | | | | | | | | | | | | | | | | | | | | | | | | | | | | | | | | | | | | | | | | | | | | | | | | | | | | | | | | | | | | | | | | | | | | | | | | | | | | | | | | | | | | | | | | | | | | | | | | | | | | | | | | | | | | | | | | | | | | | | | | | | | | | | | | | | | | | | | | | | | | | | | | | | | | | | | | | | | | | | | | | | | | | | | | | | | | | | | | | | | | | | | | | | | | | | | | | | | | | | | | | | | | | | | | | | | | | | | | | | | | | | | | | | | | | | | | | | | | | | | | | | | | | | | | | | | | | | | | | | | | | | | | | | | | | | | | | | | | | | | | | | | | | | | | | | | | | | | | | | | | | | | | | | | | | | | | | | | | | | | | | | | | | | | | | | | | | | | | | | | | | | | | | | | | | | | | | | | | | | | | | | | | | | | | | | | | | | | | | | | | | | | | | | | | | | | | | | | | | | | | | | | | | | | | | | | | | | | | | | | | | | | | | | | | | | | | | | | | | | | | | | | | | | | | | | | | | | | | | | | | | | | | | | | | | | | | | | | | | | | | | | | | | | | | | | | | | | | | | | | | | | | | | | | | | | | | | | | | | | | | | | | | | | | | | | | | | | | | | | | | | | | | | | | | | | | | | |
| 12 | | | | | | | | | | | | | | | | | | | | | | | | | | | | | | | | | | | | | | | | | | | | | | | | | | | | | | | | | | | | | | | | | | | | | | | | | | | | | | | | | | | | | | | | | | | | | | | | | | | | | | | | | | | | | | | | | | | | | | | | | | | | | | | | | | | | | | | | | | | | | | | | | | | | | | | | | | | | | | | | | | | | | | | | | | | | | | | | | | | | | | | | | | | | | | | | | | | | | | | | | | | | | | | | | | | | | | | | | | | | | | | | | | | | | | | | | | | | | | | | | | | | | | | | | | | | | | | | | | | | | | | | | | | | | | | | | | | | | | | | | | | | | | | | | | | | | | | | | | | | | | | | | | | | | | | | | | | | | | | | | | | | | | | | | | | | | | | | | | | | | | | | | | | | | | | | | | | | | | | | | | | | | | | | | | | | | | | | | | | | | | | | | | | | | | | | | | | | | | | | | | | | | | | | | | | | | | | | | | | | | | | | | | | | | | | | | | | | | | | | | | | | | | | | | | | | | | | | | | | | | | | | | | | | | | | | | | | | | | | | | | | | | | | | | | | | | | | | | | | | | | | | | | | | | | | | | | | | | | | | | | | | | | | | | | | | | | | | | | | | | | | | | | | | | | | | | | | | | | | | | | | | | | | | | | | | | | | | | | | | | | | | | | | | | | | | | | | | | | | | | | | | | | | | | | | | | | | | | | | | | | | | | | | | | | | | | | | | | | | | | | | | | | | | | | | | | | | | | | | | | | | | | | | | | | | | | | | | | | | | | | | | | | | | | | | | | | | | | | | | | | | | | | | | | | | | | | | | | | | | | | | | | | | | | | | | | | | | | | | | | | | | | | | | | | | | | | | | | | | | | | | | | | | | | | | | | | | | | | | | | | | | | | | | | | | | | | | | | | | | | | | | | | | | | | | | | | | | | | | | | | | | | | | | | | | | | | | | | | | | | | | | | | | | | | | | | | | | | | | | | | | | | | | | | | | | | | | | | | | | | | | | | | | | | | | | | | | | | | | | | | | | | | | | | | | | | | | | | | | | | | | | | | | | | | | | | | | | | | | | | | | | | | | | | | | | | | | | | | | | | | | | | | | | | | | | | | | | | | | | | | | | | | | | | | | | | | | | | | | | | | | | | | | | | | | | | | | | | | | | | | | | | | | | | | | | | | | | | | | | | | | | | | | | | | | | | | | | | | | | | | | | | | | | | | | |
| 15 | | | | | | | | | | | | | | | | | | | | | | | | | | | | | | | | | | | | | | | | | | | | | | | | | | | | | | | | | | | | | | | | | | | | | | | | | | | | | | | | | | | | | | | | | | | | | | | | | | | | | | | | | | | | | | | | | | | | | | | | | | | | | | | | | | | | | | | | | | | | | | | | | | | | | | | | | | | | | | | | | | | | | | | | | | | | | | | | | | | | | | | | | | | | | | | | | | | | | | | | | | | | | | | | | | | | | | | | | | | | | | | | | | | | | | | | | | | | | | | | | | | | | | | | | | | | | | | | | | | | | | | | | | | | | | | | | | | | | | | | | | | | | | | | | | | | | | | | | | | | | | | | | | | | | | | | | | | | | | | | | | | | | | | | | | | | | | | | | | | | | | | | | | | | | | | | | | | | | | | | | | | | | | | | | | | | | | | | | | | | | | | | | | | | | | | | | | | | | | | | | | | | | | | | | | | | | | | | | | | | | | | | | | | | | | | | | | | | | | | | | | | | | | | | | | | | | | | | | | | | | | | | | | | | | | | | | | | | | | | | | | | | | | | | | | | | | | | | | | | | | | | | | | | | | | | | | | | | | | | | | | | | | | | | | | | | | | | | | | | | | | | | | | | | | | | | | | | | | | | | | | | | | | | | | | | | | | | | | | | | | | | | | | | | | | | | | | | | | | | | | | | | | | | | | | | | | | | | | | | | | | | | | | | | | | | | | | | | | | | | | | | | | | | | | | | | | | | | | | | | | | | | | | | | | | | | | | | | | | | | | | | | | | | | | | | | | | | | | | | | | | | | | | | | | | | | | | | | | | | | | | | | | | | | | | | | | | | | | | | | | | | | | | | | | | | | | | | | | | | | | | | | | | | | | | | | | | | | | | | | | | | | | | | | | | | | | | | | | | | | | | | | | | | | | | | | | | | | | | | | | | | | | | | | | | | | | | | | | | | | | | | | | | | | | | | | | | | | | | | | | | | | | | | | | | | | | | | | | | | | | | | | | | | | | | | | | | | | | | | | | | | | | | | | | | | | | | | | | | | | | | | | | | | | | | | | | | | | | | | | | | | | | | | | | | | | | | | | | | | | | | | | | | | | | | | | | | | | | | | | | | | | | | | | | | | | | | | | | | | | | | | | | | | | | | | | | | | | | | | | | | | | | | | | | | | | | | | | | | | | | | | | | | | | | | | | | | | | | | | | | | | | | | | | | | | |
| 18 | | | | | | | | | | | | | | | | | | | | | | | | | | | | | | | | | | | | | | | | | | | | | | | | | | | | | | | | | | | | | | | | | | | | | | | | | | | | | | | | | | | | | | | | | | | | | | | | | | | | | | | | | | | | | | | | | | | | | | | | | | | | | | | | | | | | | | | | | | | | | | | | | | | | | | | | | | | | | | | | | | | | | | | | | | | | | | | | | | | | | | | | | | | | | | | | | | | | | | | | | | | | | | | | | | | | | | | | | | | | | | | | | | | | | | | | | | | | | | | | | | | | | | | | | | | | | | | | | | | | | | | | | | | | | | | | | | | | | | | | | | | | | | | | | | | | | | | | | | | | | | | | | | | | | | | | | | | | | | | | | | | | | | | | | | | | | | | | | | | | | | | | | | | | | | | | | | | | | | | | | | | | | | | | | | | | | | | | | | | | | | | | | | | | | | | | | | | | | | | | | | | | | | | | | | | | | | | | | | | | | | | | | | | | | | | | | | | | | | | | | | | | | | | | | | | | | | | | | | | | | | | | | | | | | | | | | | | | | | | | | | | | | | | | | | | | | | | | | | | | | | | | | | | | | | | | | | | | | | | | | | | | | | | | | | | | | | | | | | | | | | | | | | | | | | | | | | | | | | | | | | | | | | | | | | | | | | | | | | | | | | | | | | | | | | | | | | | | | | | | | | | | | | | | | | | | | | | | | | | | | | | | | | | | | | | | | | | | | | | | | | | | | | | | | | | | | | | | | | | | | | | | | | | | | | | | | | | | | | | | | | | | | | | | | | | | | | | | | | | | | | | | | | | | | | | | | | | | | | | | | | | | | | | | | | | | | | | | | | | | | | | | | | | | | | | | | | | | | | | | | | | | | | | | | | | | | | | | | | | | | | | | | | | | | | | | | | | | | | | | | | | | | | | | | | | | | | | | | | | | | | | | | | | | | | | | | | | | | | | | | | | | | | | | | | | | | | | | | | | | | | | | | | | | | | | | | | | | | | | | | | | | | | | | | | | | | | | | | | | | | | | | | | | | | | | | | | | | | | | | | | | | | | | | | | | | | | | | | | | | | | | | | | | | | | | | | | | | | | | | | | | | | | | | | | | | | | | | | | | | | | | | | | | | | | | | | | | | | | | | | | | | | | | | | | | | | | | | | | | | | | | | | | | | | | | | | | | | | | | | | | | | | | | | | | | | | | | | | | | | | | | | | | | | | | | |
| 22 | | | | | | | | | | | | | | | | | | | | | | | | | | | | | | | | | | | | | | | | | | | | | | | | | | | | | | | | | | | | | | | | | | | | | | | | | | | | | | | | | | | | | | | | | | | | | | | | | | | | | | | | | | | | | | | | | | | | | | | | | | | | | | | | | | | | | | | | | | | | | | | | | | | | | | | | | | | | | | | | | | | | | | | | | | | | | | | | | | | | | | | | | | | | | | | | | | | | | | | | | | | | | | | | | | | | | | | | | | | | | | | | | | | | | | | | | | | | | | | | | | | | | | | | | | | | | | | | | | | | | | | | | | | | | | | | | | | | | | | | | | | | | | | | | | | | | | | | | | | | | | | | | | | | | | | | | | | | | | | | | | | | | | | | | | | | | | | | | | | | | | | | | | | | | | | | | | | | | | | | | | | | | | | | | | | | | | | | | | | | | | | | | | | | | | | | | | | | | | | | | | | | | | | | | | | | | | | | | | | | | | | | | | | | | | | | | | | | | | | | | | | | | | | | | | | | | | | | | | | | | | | | | | | | | | | | | | | | | | | | | | | | | | | | | | | | | | | | | | | | | | | | | | | | | | | | | | | | | | | | | | | | | | | | | | | | | | | | | | | | | | | | | | | | | | | | | | | | | | | | | | | | | | | | | | | | | | | | | | | | | | | | | | | | | | | | | | | | | | | | | | | | | | | | | | | | | | | | | | | | | | | | | | | | | | | | | | | | | | | | | | | | | | | | | | | | | | | | | | | | | | | | | | | | | | | | | | | | | | | | | | | | | | | | | | | | | | | | | | | | | | | | | | | | | | | | | | | | | | | | | | | | | | | | | | | | | | | | | | | | | | | | | | | | | | | | | | | | | | | | | | | | | | | | | | | | | | | | | | | | | | | | | | | | | | | | | | | | | | | | | | | | | | | | | | | | | | | | | | | | | | | | | | | | | | | | | | | | | | | | | | | | | | | | | | | | | | | | | | | | | | | | | | | | | | | | | | | | | | | | | | | | | | | | | | | | | | | | | | | | | | | | | | | | | | | | | | | | | | | | | | | | | | | | | | | | | | | | | | | | | | | | | | | | | | | | | | | | | | | | | | | | | | | | | | | | | | | | | | | | | | | | | | | | | | | | | | | | | | | | | | | | | | | | | | | | | | | | | | | | | | | | | | | | | | | | | | | | | | | | | | | | | | | | | | | | | | | | | | | | | | | | | | | | | | | |
| 27 | | | | | | | | | | | | | | | | | | | | | | | | | | | | | | | | | | | | | | | | | | | | | | | | | | | | | | | | | | | | | | | | | | | | | | | | | | | | | | | | | | | | | | | | | | | | | | | | | | | | | | | | | | | | | | | | | | | | | | | | | | | | | | | | | | | | | | | | | | | | | | | | | | | | | | | | | | | | | | | | | | | | | | | | | | | | | | | | | | | | | | | | | | | | | | | | | | | | | | | | | | | | | | | | | | | | | | | | | | | | | | | | | | | | | | | | | | | | | | | | | | | | | | | | | | | | | | | | | | | | | | | | | | | | | | | | | | | | | | | | | | | | | | | | | | | | | | | | | | | | | | | | | | | | | | | | | | | | | | | | | | | | | | | | | | | | | | | | | | | | | | | | | | | | | | | | | | | | | | | | | | | | | | | | | | | | | | | | | | | | | | | | | | | | | | | | | | | | | | | | | | | | | | | | | | | | | | | | | | | | | | | | | | | | | | | | | | | | | | | | | | | | | | | | | | | | | | | | | | | | | | | | | | | | | | | | | | | | | | | | | | | | | | | | | | | | | | | | | | | | | | | | | | | | | | | | | | | | | | | | | | | | | | | | | | | | | | | | | | | | | | | | | | | | | | | | | | | | | | | | | | | | | | | | | | | | | | | | | | | | | | | | | | | | | | | | | | | | | | | | | | | | | | | | | | | | | | | | | | | | | | | | | | | | | | | | | | | | | | | | | | | | | | | | | | | | | | | | | | | | | | | | | | | | | | | | | | | | | | | | | | | | | | | | | | | | | | | | | | | | | | | | | | | | | | | | | | | | | | | | | | | | | | | | | | | | | | | | | | | | | | | | | | | | | | | | | | | | | | | | | | | | | | | | | | | | | | | | | | | | | | | | | | | | | | | | | | | | | | | | | | | | | | | | | | | | | | | | | | | | | | | | | | | | | | | | | | | | | | | | | | | | | | | | | | | | | | | | | | | | | | | | | | | | | | | | | | | | | | | | | | | | | | | | | | | | | | | | | | | | | | | | | | | | | | | | | | | | | | | | | | | | | | | | | | | | | | | | | | | | | | | | | | | | | | | | | | | | | | | | | | | | | | | | | | | | | | | | | | | | | | | | | | | | | | | | | | | | | | | | | | | | | | | | | | | | | | | | | | | | | | | | | | | | | | | | | | | | | | | | | | | | | | | | | | | | | | | | | | | | | | | | | | | | | | | |
| 33 | | | | | | | | | | | | | | | | | | | | | | | | | | | | | | | | | | | | | | | | | | | | | | | | | | | | | | | | | | | | | | | | | | | | | | | | | | | | | | | | | | | | | | | | | | | | | | | | | | | | | | | | | | | | | | | | | | | | | | | | | | | | | | | | | | | | | | | | | | | | | | | | | | | | | | | | | | | | | | | | | | | | | | | | | | | | | | | | | | | | | | | | | | | | | | | | | | | | | | | | | | | | | | | | | | | | | | | | | | | | | | | | | | | | | | | | | | | | | | | | | | | | | | | | | | | | | | | | | | | | | | | | | | | | | | | | | | | | | | | | | | | | | | | | | | | | | | | | | | | | | | | | | | | | | | | | | | | | | | | | | | | | | | | | | | | | | | | | | | | | | | | | | | | | | | | | | | | | | | | | | | | | | | | | | | | | | | | | | | | | | | | | | | | | | | | | | | | | | | | | | | | | | | | | | | | | | | | | | | | | | | | | | | | | | | | | | | | | | | | | | | | | | | | | | | | | | | | | | | | | | | | | | | | | | | | | | | | | | | | | | | | | | | | | | | | | | | | | | | | | | | | | | | | | | | | | | | | | | | | | | | | | | | | | | | | | | | | | | | | | | | | | | | | | | | | | | | | | | | | | | | | | | | | | | | | | | | | | | | | | | | | | | | | | | | | | | | | | | | | | | | | | | | | | | | | | | | | | | | | | | | | | | | | | | | | | | | | | | | | | | | | | | | | | | | | | | | | | | | | | | | | | | | | | | | | | | | | | | | | | | | | | | | | | | | | | | | | | | | | | | | | | | | | | | | | | | | | | | | | | | | | | | | | | | | | | | | | | | | | | | | | | | | | | | | | | | | | | | | | | | | | | | | | | | | | | | | | | | | | | | | | | | | | | | | | | | | | | | | | | | | | | | | | | | | | | | | | | | | | | | | | | | | | | | | | | | | | | | | | | | | | | | | | | | | | | | | | | | | | | | | | | | | | | | | | | | | | | | | | | | | | | | | | | | | | | | | | | | | | | | | | | | | | | | | | | | | | | | | | | | | | | | | | | | | | | | | | | | | | | | | | | | | | | | | | | | | | | | | | | | | | | | | | | | | | | | | | | | | | | | | | | | | | | | | | | | | | | | | | | | | | | | | | | | | | | | | | | | | | | | | | | | | | | | | | | | | | | | | | | | | | | | | | | | | | | | | | | | | | | | | | | | | | | | | | |
| 39 | | | | | | | | | | | | | | | | | | | | | | | | | | | | | | | | | | | | | | | | | | | | | | | | | | | | | | | | | | | | | | | | | | | | | | | | | | | | | | | | | | | | | | | | | | | | | | | | | | | | | | | | | | | | | | | | | | | | | | | | | | | | | | | | | | | | | | | | | | | | | | | | | | | | | | | | | | | | | | | | | | | | | | | | | | | | | | | | | | | | | | | | | | | | | | | | | | | | | | | | | | | | | | | | | | | | | | | | | | | | | | | | | | | | | | | | | | | | | | | | | | | | | | | | | | | | | | | | | | | | | | | | | | | | | | | | | | | | | | | | | | | | | | | | | | | | | | | | | | | | | | | | | | | | | | | | | | | | | | | | | | | | | | | | | | | | | | | | | | | | | | | | | | | | | | | | | | | | | | | | | | | | | | | | | | | | | | | | | | | | | | | | | | | | | | | | | | | | | | | | | | | | | | | | | | | | | | | | | | | | | | | | | | | | | | | | | | | | | | | | | | | | | | | | | | | | | | | | | | | | | | | | | | | | | | | | | | | | | | | | | | | | | | | | | | | | | | | | | | | | | | | | | | | | | | | | | | | | | | | | | | | | | | | | | | | | | | | | | | | | | | | | | | | | | | | | | | | | | | | | | | | | | | | | | | | | | | | | | | | | | | | | | | | | | | | | | | | | | | | | | | | | | | | | | | | | | | | | | | | | | | | | | | | | | | | | | | | | | | | | | | | | | | | | | | | | | | | | | | | | | | | | | | | | | | | | | | | | | | | | | | | | | | | | | | | | | | | | | | | | | | | | | | | | | | | | | | | | | | | | | | | | | | | | | | | | | | | | | | | | | | | | | | | | | | | | | | | | | | | | | | | | | | | | | | | | | | | | | | | | | | | | | | | | | | | | | | | | | | | | | | | | | | | | | | | | | | | | | | | | | | | | | | | | | | | | | | | | | | | | | | | | | | | | | | | | | | | | | | | | | | | | | | | | | | | | | | | | | | | | | | | | | | | | | | | | | | | | | | | | | | | | | | | | | | | | | | | | | | | | | | | | | | | | | | | | | | | | | | | | | | | | | | | | | | | | | | | | | | | | | | | | | | | | | | | | | | | | | | | | | | | | | | | | | | | | | | | | | | | | | | | | | | | | | | | | | | | | | | | | | | | | | | | | | | | | | | | | | | | | | | | | | | | | | | | | | | | | | | | | | | | | | | | | | | | |
| 47 | | | | | | | | | | | | | | | | | | | | | | | | | | | | | | | | | | | | | | | | | | | | | | | | | | | | | | | | | | | | | | | | | | | | | | | | | | | | | | | | | | | | | | | | | | | | | | | | | | | | | | | | | | | | | | | | | | | | | | | | | | | | | | | | | | | | | | | | | | | | | | | | | | | | | | | | | | | | | | | | | | | | | | | | | | | | | | | | | | | | | | | | | | | | | | | | | | | | | | | | | | | | | | | | | | | | | | | | | | | | | | | | | | | | | | | | | | | | | | | | | | | | | | | | | | | | | | | | | | | | | | | | | | | | | | | | | | | | | | | | | | | | | | | | | | | | | | | | | | | | | | | | | | | | | | | | | | | | | | | | | | | | | | | | | | | | | | | | | | | | | | | | | | | | | | | | | | | | | | | | | | | | | | | | | | | | | | | | | | | | | | | | | | | | | | | | | | | | | | | | | | | | | | | | | | | | | | | | | | | | | | | | | | | | | | | | | | | | | | | | | | | | | | | | | | | | | | | | | | | | | | | | | | | | | | | | | | | | | | | | | | | | | | | | | | | | | | | | | | | | | | | | | | | | | | | | | | | | | | | | | | | | | | | | | | | | | | | | | | | | | | | | | | | | | | | | | | | | | | | | | | | | | | | | | | | | | | | | | | | | | | | | | | | | | | | | | | | | | | | | | | | | | | | | | | | | | | | | | | | | | | | | | | | | | | | | | | | | | | | | | | | | | | | | | | | | | | | | | | | | | | | | | | | | | | | | | | | | | | | | | | | | | | | | | | | | | | | | | | | | | | | | | | | | | | | | | | | | | | | | | | | | | | | | | | | | | | | | | | | | | | | | | | | | | | | | | | | | | | | | | | | | | | | | | | | | | | | | | | | | | | | | | | | | | | | | | | | | | | | | | | | | | | | | | | | | | | | | | | | | | | | | | | | | | | | | | | | | | | | | | | | | | | | | | | | | | | | | | | | | | | | | | | | | | | | | | | | | | | | | | | | | | | | | | | | | | | | | | | | | | | | | | | | | | | | | | | | | | | | | | | | | | | | | | | | | | | | | | | | | | | | | | | | | | | | | | | | | | | | | | | | | | | | | | | | | | | | | | | | | | | | | | | | | | | | | | | | | | | | | | | | | | | | | | | | | | | | | | | | | | | | | | | | | | | | | | | | | | | | | | | | | | | | | | | | | | | | | | | | | | | | | | | | | | | | |
| 56 | | | | | | | | | | | | | | | | | | | | | | | | | | | | | | | | | | | | | | | | | | | | | | | | | | | | | | | | | | | | | | | | | | | | | | | | | | | | | | | | | | | | | | | | | | | | | | | | | | | | | | | | | | | | | | | | | | | | | | | | | | | | | | | | | | | | | | | | | | | | | | | | | | | | | | | | | | | | | | | | | | | | | | | | | | | | | | | | | | | | | | | | | | | | | | | | | | | | | | | | | | | | | | | | | | | | | | | | | | | | | | | | | | | | | | | | | | | | | | | | | | | | | | | | | | | | | | | | | | | | | | | | | | | | | | | | | | | | | | | | | | | | | | | | | | | | | | | | | | | | | | | | | | | | | | | | | | | | | | | | | | | | | | | | | | | | | | | | | | | | | | | | | | | | | | | | | | | | | | | | | | | | | | | | | | | | | | | | | | | | | | | | | | | | | | | | | | | | | | | | | | | | | | | | | | | | | | | | | | | | | | | | | | | | | | | | | | | | | | | | | | | | | | | | | | | | | | | | | | | | | | | | | | | | | | | | | | | | | | | | | | | | | | | | | | | | | | | | | | | | | | | | | | | | | | | | | | | | | | | | | | | | | | | | | | | | | | | | | | | | | | | | | | | | | | | | | | | | | | | | | | | | | | | | | | | | | | | | | | | | | | | | | | | | | | | | | | | | | | | | | | | | | | | | | | | | | | | | | | | | | | | | | | | | | | | | | | | | | | | | | | | | | | | | | | | | | | | | | | | | | | | | | | | | | | | | | | | | | | | | | | | | | | | | | | | | | | | | | | | | | | | | | | | | | | | | | | | | | | | | | | | | | | | | | | | | | | | | | | | | | | | | | | | | | | | | | | | | | | | | | | | | | | | | | | | | | | | | | | | | | | | | | | | | | | | | | | | | | | | | | | | | | | | | | | | | | | | | | | | | | | | | | | | | | | | | | | | | | | | | | | | | | | | | | | | | | | | | | | | | | | | | | | | | | | | | | | | | | | | | | | | | | | | | | | | | | | | | | | | | | | | | | | | | | | | | | | | | | | | | | | | | | | | | | | | | | | | | | | | | | | | | | | | | | | | | | | | | | | | | | | | | | | | | | | | | | | | | | | | | | | | | | | | | | | | | | | | | | | | | | | | | | | | | | | | | | | | | | | | | | | | | | | | | | | | | | | | | | | | | | | | | | | | | | | | | | | | | | | | | | | | | | | | | | | | |
| 68 | | | | | | | | | | | | | | | | | | | | | | | | | | | | | | | | | | | | | | | | | | | | | | | | | | | | | | | | | | | | | | | | | | | | | | | | | | | | | | | | | | | | | | | | | | | | | | | | | | | | | | | | | | | | | | | | | | | | | | | | | | | | | | | | | | | | | | | | | | | | | | | | | | | | | | | | | | | | | | | | | | | | | | | | | | | | | | | | | | | | | | | | | | | | | | | | | | | | | | | | | | | | | | | | | | | | | | | | | | | | | | | | | | | | | | | | | | | | | | | | | | | | | | | | | | | | | | | | | | | | | | | | | | | | | | | | | | | | | | | | | | | | | | | | | | | | | | | | | | | | | | | | | | | | | | | | | | | | | | | | | | | | | | | | | | | | | | | | | | | | | | | | | | | | | | | | | | | | | | | | | | | | | | | | | | | | | | | | | | | | | | | | | | | | | | | | | | | | | | | | | | | | | | | | | | | | | | | | | | | | | | | | | | | | | | | | | | | | | | | | | | | | | | | | | | | | | | | | | | | | | | | | | | | | | | | | | | | | | | | | | | | | | | | | | | | | | | | | | | | | | | | | | | | | | | | | | | | | | | | | | | | | | | | | | | | | | | | | | | | | | | | | | | | | | | | | | | | | | | | | | | | | | | | | | | | | | | | | | | | | | | | | | | | | | | | | | | | | | | | | | | | | | | | | | | | | | | | | | | | | | | | | | | | | | | | | | | | | | | | | | | | | | | | | | | | | | | | | | | | | | | | | | | | | | | | | | | | | | | | | | | | | | | | | | | | | | | | | | | | | | | | | | | | | | | | | | | | | | | | | | | | | | | | | | | | | | | | | | | | | | | | | | | | | | | | | | | | | | | | | | | | | | | | | | | | | | | | | | | | | | | | | | | | | | | | | | | | | | | | | | | | | | | | | | | | | | | | | | | | | | | | | | | | | | | | | | | | | | | | | | | | | | | | | | | | | | | | | | | | | | | | | | | | | | | | | | | | | | | | | | | | | | | | | | | | | | | | | | | | | | | | | | | | | | | | | | | | | | | | | | | | | | | | | | | | | | | | | | | | | | | | | | | | | | | | | | | | | | | | | | | | | | | | | | | | | | | | | | | | | | | | | | | | | | | | | | | | | | | | | | | | | | | | | | | | | | | | | | | | | | | | | | | | | | | | | | | | | | | | | | | | | | | | | | | | | | | | | | | | | | | | | | | | | | | | |
| 82 | | | | | | | | | | | | | | | | | | | | | | | | | | | | | | | | | | | | | | | | | | | | | | | | | | | | | | | | | | | | | | | | | | | | | | | | | | | | | | | | | | | | | | | | | | | | | | | | | | | | | | | | | | | | | | | | | | | | | | | | | | | | | | | | | | | | | | | | | | | | | | | | | | | | | | | | | | | | | | | | | | | | | | | | | | | | | | | | | | | | | | | | | | | | | | | | | | | | | | | | | | | | | | | | | | | | | | | | | | | | | | | | | | | | | | | | | | | | | | | | | | | | | | | | | | | | | | | | | | | | | | | | | | | | | | | | | | | | | | | | | | | | | | | | | | | | | | | | | | | | | | | | | | | | | | | | | | | | | | | | | | | | | | | | | | | | | | | | | | | | | | | | | | | | | | | | | | | | | | | | | | | | | | | | | | | | | | | | | | | | | | | | | | | | | | | | | | | | | | | | | | | | | | | | | | | | | | | | | | | | | | | | | | | | | | | | | | | | | | | | | | | | | | | | | | | | | | | | | | | | | | | | | | | | | | | | | | | | | | | | | | | | | | | | | | | | | | | | | | | | | | | | | | | | | | | | | | | | | | | | | | | | | | | | | | | | | | | | | | | | | | | | | | | | | | | | | | | | | | | | | | | | | | | | | | | | | | | | | | | | | | | | | | | | | | | | | | | | | | | | | | | | | | | | | | | | | | | | | | | | | | | | | | | | | | | | | | | | | | | | | | | | | | | | | | | | | | | | | | | | | | | | | | | | | | | | | | | | | | | | | | | | | | | | | | | | | | | | | | | | | | | | | | | | | | | | | | | | | | | | | | | | | | | | | | | | | | | | | | | | | | | | | | | | | | | | | | | | | | | | | | | | | | | | | | | | | | | | | | | | | | | | | | | | | | | | | | | | | | | | | | | | | | | | | | | | | | | | | | | | | | | | | | | | | | | | | | | | | | | | | | | | | | | | | | | | | | | | | | | | | | | | | | | | | | | | | | | | | | | | | | | | | | | | | | | | | | | | | | | | | | | | | | | | | | | | | | | | | | | | | | | | | | | | | | | | | | | | | | | | | | | | | | | | | | | | | | | | | | | | | | | | | | | | | | | | | | | | | | | | | | | | | | | | | | | | | | | | | | | | | | | | | | | | | | | | | | | | | | | | | | | | | | | | | | | | | | | | | | | | | | | | | | | | | | | | | | | | | | | | | | | | | | | | | | | |
| 100 | | | | | | | | | | | | | | | | | | | | | | | | | | | | | | | | | | | | | | | | | | | | | | | | | | | | | | | | | | | | | | | | | | | | | | | | | | | | | | | | | | | | | | | | | | | | | | | | | | | | | | | | | | | | | | | | | | | | | | | | | | | | | | | | | | | | | | | | | | | | | | | | | | | | | | | | | | | | | | | | | | | | | | | | | | | | | | | | | | | | | | | | | | | | | | | | | | | | | | | | | | | | | | | | | | | | | | | | | | | | | | | | | | | | | | | | | | | | | | | | | | | | | | | | | | | | | | | | | | | | | | | | | | | | | | | | | | | | | | | | | | | | | | | | | | | | | | | | | | | | | | | | | | | | | | | | | | | | | | | | | | | | | | | | | | | | | | | | | | | | | | | | | | | | | | | | | | | | | | | | | | | | | | | | | | | | | | | | | | | | | | | | | | | | | | | | | | | | | | | | | | | | | | | | | | | | | | | | | | | | | | | | | | | | | | | | | | | | | | | | | | | | | | | | | | | | | | | | | | | | | | | | | | | | | | | | | | | | | | | | | | | | | | | | | | | | | | | | | | | | | | | | | | | | | | | | | | | | | | | | | | | | | | | | | | | | | | | | | | | | | | | | | | | | | | | | | | | | | | | | | | | | | | | | | | | | | | | | | | | | | | | | | | | | | | | | | | | | | | | | | | | | | | | | | | | | | | | | | | | | | | | | | | | | | | | | | | | | | | | | | | | | | | | | | | | | | | | | | | | | | | | | | | | | | | | | | | | | | | | | | | | | | | | | | | | | | | | | | | | | | | | | | | | | | | | | | | | | | | | | | | | | | | | | | | | | | | | | | | | | | | | | | | | | | | | | | | | | | | | | | | | | | | | | | | | | | | | | | | | | | | | | | | | | | | | | | | | | | | | | | | | | | | | | | | | | | | | | | | | | | | | | | | | | | | | | | | | | | | | | | | | | | | | | | | | | | | | | | | | | | | | | | | | | | | | | | | | | | | | | | | | | | | | | | | | | | | | | | | | | | | | | | | | | | | | | | | | | | | | | | | | | | | | | | | | | | | | | | | | | | | | | | | | | | | | | | | | | | | | | | | | | | | | | | | | | | | | | | | | | | | | | | | | | | | | | | | | | | | | | | | | | | | | | | | | | | | | | | | | | | | | | | | | | | | | | | | | | | | | | | | | | | | | | | | | | | | | | | | | | | | | | | | | | | | | |
| 120 | | | | | | | | | | | | | | | | | | | | | | | | | | | | | | | | | | | | | | | | | | | | | | | | | | | | | | | | | | | | | | | | | | | | | | | | | | | | | | | | | | | | | | | | | | | | | | | | | | | | | | | | | | | | | | | | | | | | | | | | | | | | | | | | | | | | | | | | | | | | | | | | | | | | | | | | | | | | | | | | | | | | | | | | | | | | | | | | | | | | | | | | | | | | | | | | | | | | | | | | | | | | | | | | | | | | | | | | | | | | | | | | | | | | | | | | | | | | | | | | | | | | | | | | | | | | | | | | | | | | | | | | | | | | | | | | | | | | | | | | | | | | | | | | | | | | | | | | | | | | | | | | | | | | | | | | | | | | | | | | | | | | | | | | | | | | | | | | | | | | | | | | | | | | | | | | | | | | | | | | | | | | | | | | | | | | | | | | | | | | | | | | | | | | | | | | | | | | | | | | | | | | | | | | | | | | | | | | | | | | | | | | | | | | | | | | | | | | | | | | | | | | | | | | | | | | | | | | | | | | | | | | | | | | | | | | | | | | | | | | | | | | | | | | | | | | | | | | | | | | | | | | | | | | | | | | | | | | | | | | | | | | | | | | | | | | | | | | | | | | | | | | | | | | | | | | | | | | | | | | | | | | | | | | | | | | | | | | | | | | | | | | | | | | | | | | | | | | | | | | | | | | | | | | | | | | | | | | | | | | | | | | | | | | | | | | | | | | | | | | | | | | | | | | | | | | | | | | | | | | | | | | | | | | | | | | | | | | | | | | | | | | | | | | | | | | | | | | | | | | | | | | | | | | | | | | | | | | | | | | | | | | | | | | | | | | | | | | | | | | | | | | | | | | | | | | | | | | | | | | | | | | | | | | | | | | | | | | | | | | | | | | | | | | | | | | | | | | | | | | | | | | | | | | | | | | | | | | | | | | | | | | | | | | | | | | | | | | | | | | | | | | | | | | | | | | | | | | | | | | | | | | | | | | | | | | | | | | | | | | | | | | | | | | | | | | | | | | | | | | | | | | | | | | | | | | | | | | | | | | | | | | | | | | | | | | | | | | | | | | | | | | | | | | | | | | | | | | | | | | | | | | | | | | | | | | | | | | | | | | | | | | | | | | | | | | | | | | | | | | | | | | | | | | | | | | | | | | | | | | | | | | | | | | | | | | | | | | | | | | | | | | | | | | | | | | | | | | | | | | | | | | | | | | | | | |
| 150 | | | | | | | | | | | | | | | | | | | | | | | | | | | | | | | | | | | | | | | | | | | | | | | | | | | | | | | | | | | | | | | | | | | | | | | | | | | | | | | | | | | | | | | | | | | | | | | | | | | | | | | | | | | | | | | | | | | | | | | | | | | | | | | | | | | | | | | | | | | | | | | | | | | | | | | | | | | | | | | | | | | | | | | | | | | | | | | | | | | | | | | | | | | | | | | | | | | | | | | | | | | | | | | | | | | | | | | | | | | | | | | | | | | | | | | | | | | | | | | | | | | | | | | | | | | | | | | | | | | | | | | | | | | | | | | | | | | | | | | | | | | | | | | | | | | | | | | | | | | | | | | | | | | | | | | | | | | | | | | | | | | | | | | | | | | | | | | | | | | | | | | | | | | | | | | | | | | | | | | | | | | | | | | | | | | | | | | | | | | | | | | | | | | | | | | | | | | | | | | | | | | | | | | | | | | | | | | | | | | | | | | | | | | | | | | | | | | | | | | | | | | | | | | | | | | | | | | | | | | | | | | | | | | | | | | | | | | | | | | | | | | | | | | | | | | | | | | | | | | | | | | | | | | | | | | | | | | | | | | | | | | | | | | | | | | | | | | | | | | | | | | | | | | | | | | | | | | | | | | | | | | | | | | | | | | | | | | | | | | | | | | | | | | | | | | | | | | | | | | | | | | | | | | | | | | | | | | | | | | | | | | | | | | | | | | | | | | | | | | | | | | | | | | | | | | | | | | | | | | | | | | | | | | | | | | | | | | | | | | | | | | | | | | | | | | | | | | | | | | | | | | | | | | | | | | | | | | | | | | | | | | | | | | | | | | | | | | | | | | | | | | | | | | | | | | | | | | | | | | | | | | | | | | | | | | | | | | | | | | | | | | | | | | | | | | | | | | | | | | | | | | | | | | | | | | | | | | | | | | | | | | | | | | | | | | | | | | | | | | | | | | | | | | | | | | | | | | | | | | | | | | | | | | | | | | | | | | | | | | | | | | | | | | | | | | | | | | | | | | | | | | | | | | | | | | | | | | | | | | | | | | | | | | | | | | | | | | | | | | | | | | | | | | | | | | | | | | | | | | | | | | | | | | | | | | | | | | | | | | | | | | | | | | | | | | | | | | | | | | | | | | | | | | | | | | | | | | | | | | | | | | | | | | | | | | | | | | | | | | | | | | | | | | | | | | | | | | | | | | | | | | | | | | | | | | |
| 180 | | | | | | | | | | | | | | | | | | | | | | | | | | | | | | | | | | | | | | | | | | | | | | | | | | | | | | | | | | | | | | | | | | | | | | | | | | | | | | | | | | | | | | | | | | | | | | | | | | | | | | | | | | | | | | | | | | | | | | | | | | | | | | | | | | | | | | | | | | | | | | | | | | | | | | | | | | | | | | | | | | | | | | | | | | | | | | | | | | | | | | | | | | | | | | | | | | | | | | | | | | | | | | | | | | | | | | | | | | | | | | | | | | | | | | | | | | | | | | | | | | | | | | | | | | | | | | | | | | | | | | | | | | | | | | | | | | | | | | | | | | | | | | | | | | | | | | | | | | | | | | | | | | | | | | | | | | | | | | | | | | | | | | | | | | | | | | | | | | | | | | | | | | | | | | | | | | | | | | | | | | | | | | | | | | | | | | | | | | | | | | | | | | | | | | | | | | | | | | | | | | | | | | | | | | | | | | | | | | | | | | | | | | | | | | | | | | | | | | | | | | | | | | | | | | | | | | | | | | | | | | | | | | | | | | | | | | | | | | | | | | | | | | | | | | | | | | | | | | | | | | | | | | | | | | | | | | | | | | | | | | | | | | | | | | | | | | | | | | | | | | | | | | | | | | | | | | | | | | | | | | | | | | | | | | | | | | | | | | | | | | | | | | | | | | | | | | | | | | | | | | | | | | | | | | | | | | | | | | | | | | | | | | | | | | | | | | | | | | | | | | | | | | | | | | | | | | | | | | | | | | | | | | | | | | | | | | | | | | | | | | | | | | | | | | | | | | | | | | | | | | | | | | | | | | | | | | | | | | | | | | | | | | | | | | | | | | | | | | | | | | | | | | | | | | | | | | | | | | | | | | | | | | | | | | | | | | | | | | | | | | | | | | | | | | | | | | | | | | | | | | | | | | | | | | | | | | | | | | | | | | | | | | | | | | | | | | | | | | | | | | | | | | | | | | | | | | | | | | | | | | | | | | | | | | | | | | | | | | | | | | | | | | | | | | | | | | | | | | | | | | | | | | | | | | | | | | | | | | | | | | | | | | | | | | | | | | | | | | | | | | | | | | | | | | | | | | | | | | | | | | | | | | | | | | | | | | | | | | | | | | | | | | | | | | | | | | | | | | | | | | | | | | | | | | | | | | | | | | | | | | | | | | | | | | | | | | | | | | | | | | | | | | | | | | | | | | | | | | | | | | | | | | | | | | | |
| 220 | | | | | | | | | | | | | | | | | | | | | | | | | | | | | | | | | | | | | | | | | | | | | | | | | | | | | | | | | | | | | | | | | | | | | | | | | | | | | | | | | | | | | | | | | | | | | | | | | | | | | | | | | | | | | | | | | | | | | | | | | | | | | | | | | | | | | | | | | | | | | | | | | | | | | | | | | | | | | | | | | | | | | | | | | | | | | | | | | | | | | | | | | | | | | | | | | | | | | | | | | | | | | | | | | | | | | | | | | | | | | | | | | | | | | | | | | | | | | | | | | | | | | | | | | | | | | | | | | | | | | | | | | | | | | | | | | | | | | | | | | | | | | | | | | | | | | | | | | | | | | | | | | | | | | | | | | | | | | | | | | | | | | | | | | | | | | | | | | | | | | | | | | | | | | | | | | | | | | | | | | | | | | | | | | | | | | | | | | | | | | | | | | | | | | | | | | | | | | | | | | | | | | | | | | | | | | | | | | | | | | | | | | | | | | | | | | | | | | | | | | | | | | | | | | | | | | | | | | | | | | | | | | | | | | | | | | | | | | | | | | | | | | | | | | | | | | | | | | | | | | | | | | | | | | | | | | | | | | | | | | | | | | | | | | | | | | | | | | | | | | | | | | | | | | | | | | | | | | | | | | | | | | | | | | | | | | | | | | | | | | | | | | | | | | | | | | | | | | | | | | | | | | | | | | | | | | | | | | | | | | | | | | | | | | | | | | | | | | | | | | | | | | | | | | | | | | | | | | | | | | | | | | | | | | | | | | | | | | | | | | | | | | | | | | | | | | | | | | | | | | | | | | | | | | | | | | | | | | | | | | | | | | | | | | | | | | | | | | | | | | | | | | | | | | | | | | | | | | | | | | | | | | | | | | | | | | | | | | | | | | | | | | | | | | | | | | | | | | | | | | | | | | | | | | | | | | | | | | | | | | | | | | | | | | | | | | | | | | | | | | | | | | | | | | | | | | | | | | | | | | | | | | | | | | | | | | | | | | | | | | | | | | | | | | | | | | | | | | | | | | | | | | | | | | | | | | | | | | | | | | | | | | | | | | | | | | | | | | | | | | | | | | | | | | | | | | | | | | | | | | | | | | | | | | | | | | | | | | | | | | | | | | | | | | | | | | | | | | | | | | | | | | | | | | | | | | | | | | | | | | | | | | | | | | | | | | | | | | | | | | | | | | | | | | | | | | | | | | | | | | | | | | | | | | | | |
| 270 | | | | | | | | | | | | | | | | | | | | | | | | | | | | | | | | | | | | | | | | | | | | | | | | | | | | | | | | | | | | | | | | | | | | | | | | | | | | | | | | | | | | | | | | | | | | | | | | | | | | | | | | | | | | | | | | | | | | | | | | | | | | | | | | | | | | | | | | | | | | | | | | | | | | | | | | | | | | | | | | | | | | | | | | | | | | | | | | | | | | | | | | | | | | | | | | | | | | | | | | | | | | | | | | | | | | | | | | | | | | | | | | | | | | | | | | | | | | | | | | | | | | | | | | | | | | | | | | | | | | | | | | | | | | | | | | | | | | | | | | | | | | | | | | | | | | | | | | | | | | | | | | | | | | | | | | | | | | | | | | | | | | | | | | | | | | | | | | | | | | | | | | | | | | | | | | | | | | | | | | | | | | | | | | | | | | | | | | | | | | | | | | | | | | | | | | | | | | | | | | | | | | | | | | | | | | | | | | | | | | | | | | | | | | | | | | | | | | | | | | | | | | | | | | | | | | | | | | | | | | | | | | | | | | | | | | | | | | | | | | | | | | | | | | | | | | | | | | | | | | | | | | | | | | | | | | | | | | | | | | | | | | | | | | | | | | | | | | | | | | | | | | | | | | | | | | | | | | | | | | | | | | | | | | | | | | | | | | | | | | | | | | | | | | | | | | | | | | | | | | | | | | | | | | | | | | | | | | | | | | | | | | | | | | | | | | | | | | | | | | | | | | | | | | | | | | | | | | | | | | | | | | | | | | | | | | | | | | | | | | | | | | | | | | | | | | | | | | | | | | | | | | | | | | | | | | | | | | | | | | | | | | | | | | | | | | | | | | | | | | | | | | | | | | | | | | | | | | | | | | | | | | | | | | | | | | | | | | | | | | | | | | | | | | | | | | | | | | | | | | | | | | | | | | | | | | | | | | | | | | | | | | | | | | | | | | | | | | | | | | | | | | | | | | | | | | | | | | | | | | | | | | | | | | | | | | | | | | | | | | | | | | | | | | | | | | | | | | | | | | | | | | | | | | | | | | | | | | | | | | | | | | | | | | | | | | | | | | | | | | | | | | | | | | | | | | | | | | | | | | | | | | | | | | | | | | | | | | | | | | | | | | | | | | | | | | | | | | | | | | | | | | | | | | | | | | | | | | | | | | | | | | | | | | | | | | | | | | | | | | | | | | | | | | | | | | | | | | | | | | | | | | | | | | | | | |
| 330 | | | | | | | | | | | | | | | | | | | | | | | | | | | | | | | | | | | | | | | | | | | | | | | | | | | | | | | | | | | | | | | | | | | | | | | | | | | | | | | | | | | | | | | | | | | | | | | | | | | | | | | | | | | | | | | | | | | | | | | | | | | | | | | | | | | | | | | | | | | | | | | | | | | | | | | | | | | | | | | | | | | | | | | | | | | | | | | | | | | | | | | | | | | | | | | | | | | | | | | | | | | | | | | | | | | | | | | | | | | | | | | | | | | | | | | | | | | | | | | | | | | | | | | | | | | | | | | | | | | | | | | | | | | | | | | | | | | | | | | | | | | | | | | | | | | | | | | | | | | | | | | | | | | | | | | | | | | | | | | | | | | | | | | | | | | | | | | | | | | | | | | | | | | | | | | | | | | | | | | | | | | | | | | | | | | | | | | | | | | | | | | | | | | | | | | | | | | | | | | | | | | | | | | | | | | | | | | | | | | | | | | | | | | | | | | | | | | | | | | | | | | | | | | | | | | | | | | | | | | | | | | | | | | | | | | | | | | | | | | | | | | | | | | | | | | | | | | | | | | | | | | | | | | | | | | | | | | | | | | | | | | | | | | | | | | | | | | | | | | | | | | | | | | | | | | | | | | | | | | | | | | | | | | | | | | | | | | | | | | | | | | | | | | | | | | | | | | | | | | | | | | | | | | | | | | | | | | | | | | | | | | | | | | | | | | | | | | | | | | | | | | | | | | | | | | | | | | | | | | | | | | | | | | | | | | | | | | | | | | | | | | | | | | | | | | | | | | | | | | | | | | | | | | | | | | | | | | | | | | | | | | | | | | | | | | | | | | | | | | | | | | | | | | | | | | | | | | | | | | | | | | | | | | | | | | | | | | | | | | | | | | | | | | | | | | | | | | | | | | | | | | | | | | | | | | | | | | | | | | | | | | | | | | | | | | | | | | | | | | | | | | | | | | | | | | | | | | | | | | | | | | | | | | | | | | | | | | | | | | | | | | | | | | | | | | | | | | | | | | | | | | | | | | | | | | | | | | | | | | | | | | | | | | | | | | | | | | | | | | | | | | | | | | | | | | | | | | | | | | | | | | | | | | | | | | | | | | | | | | | | | | | | | | | | | | | | | | | | | | | | | | | | | | | | | | | | | | | | | | | | | | | | | | | | | | | | | | | | | | | | | | | | | | | | | | | | | | | | | | | | | | | | | | | | | | |
| 390 | | | | | | | | | | | | | | | | | | | | | | | | | | | | | | | | | | | | | | | | | | | | | | | | | | | | | | | | | | | | | | | | | | | | | | | | | | | | | | | | | | | | | | | | | | | | | | | | | | | | | | | | | | | | | | | | | | | | | | | | | | | | | | | | | | | | | | | | | | | | | | | | | | | | | | | | | | | | | | | | | | | | | | | | | | | | | | | | | | | | | | | | | | | | | | | | | | | | | | | | | | | | | | | | | | | | | | | | | | | | | | | | | | | | | | | | | | | | | | | | | | | | | | | | | | | | | | | | | | | | | | | | | | | | | | | | | | | | | | | | | | | | | | | | | | | | | | | | | | | | | | | | | | | | | | | | | | | | | | | | | | | | | | | | | | | | | | | | | | | | | | | | | | | | | | | | | | | | | | | | | | | | | | | | | | | | | | | | | | | | | | | | | | | | | | | | | | | | | | | | | | | | | | | | | | | | | | | | | | | | | | | | | | | | | | | | | | | | | | | | | | | | | | | | | | | | | | | | | | | | | | | | | | | | | | | | | | | | | | | | | | | | | | | | | | | | | | | | | | | | | | | | | | | | | | | | | | | | | | | | | | | | | | | | | | | | | | | | | | | | | | | | | | | | | | | | | | | | | | | | | | | | | | | | | | | | | | | | | | | | | | | | | | | | | | | | | | | | | | | | | | | | | | | | | | | | | | | | | | | | | | | | | | | | | | | | | | | | | | | | | | | | | | | | | | | | | | | | | | | | | | | | | | | | | | | | | | | | | | | | | | | | | | | | | | | | | | | | | | | | | | | | | | | | | | | | | | | | | | | | | | | | | | | | | | | | | | | | | | | | | | | | | | | | | | | | | | | | | | | | | | | | | | | | | | | | | | | | | | | | | | | | | | | | | | | | | | | | | | | | | | | | | | | | | | | | | | | | | | | | | | | | | | | | | | | | | | | | | | | | | | | | | | | | | | | | | | | | | | | | | | | | | | | | | | | | | | | | | | | | | | | | | | | | | | | | | | | | | | | | | | | | | | | | | | | | | | | | | | | | | | | | | | | | | | | | | | | | | | | | | | | | | | | | | | | | | | | | | | | | | | | | | | | | | | | | | | | | | | | | | | | | | | | | | | | | | | | | | | | | | | | | | | | | | | | | | | | | | | | | | | | | | | | | | | | | | | | | | | | | | | | | | | | | | | | | | | | | | | | | | | | | | | | | | | | |
| 470 | | | | | | | | | | | | | | | | | | | | | | | | | | | | | | | | | | | | | | | | | | | | | | | | | | | | | | | | | | | | | | | | | | | | | | | | | | | | | | | | | | | | | | | | | | | | | | | | | | | | | | | | | | | | | | | | | | | | | | | | | | | | | | | | | | | | | | | | | | | | | | | | | | | | | | | | | | | | | | | | | | | | | | | | | | | | | | | | | | | | | | | | | | | | | | | | | | | | | | | | | | | | | | | | | | | | | | | | | | | | | | | | | | | | | | | | | | | | | | | | | | | | | | | | | | | | | | | | | | | | | | | | | | | | | | | | | | | | | | | | | | | | | | | | | | | | | | | | | | | | | | | | | | | | | | | | | | | | | | | | | | | | | | | | | | | | | | | | | | | | | | | | | | | | | | | | | | | | | | | | | | | | | | | | | | | | | | | | | | | | | | | | | | | | | | | | | | | | | | | | | | | | | | | | | | | | | | | | | | | | | | | | | | | | | | | | | | | | | | | | | | | | | | | | | | | | | | | | | | | | | | | | | | | | | | | | | | | | | | | | | | | | | | | | | | | | | | | | | | | | | | | | | | | | | | | | | | | | | | | | | | | | | | | | | | | | | | | | | | | | | | | | | | | | | | | | | | | | | | | | | | | | | | | | | | | | | | | | | | | | | | | | | | | | | | | | | | | | | | | | | | | | | | | | | | | | | | | | | | | | | | | | | | | | | | | | | | | | | | | | | | | | | | | | | | | | | | | | | | | | | | | | | | | | | | | | | | | | | | | | | | | | | | | | | | | | | | | | | | | | | | | | | | | | | | | | | | | | | | | | | | | | | | | | | | | | | | | | | | | | | | | | | | | | | | | | | | | | | | | | | | | | | | | | | | | | | | | | | | | | | | | | | | | | | | | | | | | | | | | | | | | | | | | | | | | | | | | | | | | | | | | | | | | | | | | | | | | | | | | | | | | | | | | | | | | | | | | | | | | | | | | | | | | | | | | | | | | | | | | | | | | | | | | | | | | | | | | | | | | | | | | | | | | | | | | | | | | | | | | | | | | | | | | | | | | | | | | | | | | | | | | | | | | | | | | | | | | | | | | | | | | | | | | | | | | | | | | | | | | | | | | | | | | | | | | | | | | | | | | | | | | | | | | | | | | | | | | | | | | | | | | | | | | | | | | | | | | | | | | | | | | | | | | | | | | | | | | | | | | | | | | | | | | | | | | |
| 560 | | | | | | | | | | | | | | | | | | | | | | | | | | | | | | | | | | | | | | | | | | | | | | | | | | | | | | | | | | | | | | | | | | | | | | | | | | | | | | | | | | | | | | | | | | | | | | | | | | | | | | | | | | | | | | | | | | | | | | | | | | | | | | | | | | | | | | | | | | | | | | | | | | | | | | | | | | | | | | | | | | | | | | | | | | | | | | | | | | | | | | | | | | | | | | | | | | | | | | | | | | | | | | | | | | | | | | | | | | | | | | | | | | | | | | | | | | | | | | | | | | | | | | | | | | | | | | | | | | | | | | | | | | | | | | | | | | | | | | | | | | | | | | | | | | | | | | | | | | | | | | | | | | | | | | | | | | | | | | | | | | | | | | | | | | | | | | | | | | | | | | | | | | | | | | | | | | | | | | | | | | | | | | | | | | | | | | | | | | | | | | | | | | | | | | | | | | | | | | | | | | | | | | | | | | | | | | | | | | | | | | | | | | | | | | | | | | | | | | | | | | | | | | | | | | | | | | | | | | | | | | | | | | | | | | | | | | | | | | | | | | | | | | | | | | | | | | | | | | | | | | | | | | | | | | | | | | | | | | | | | | | | | | | | | | | | | | | | | | | | | | | | | | | | | | | | | | | | | | | | | | | | | | | | | | | | | | | | | | | | | | | | | | | | | | | | | | | | | | | | | | | | | | | | | | | | | | | | | | | | | | | | | | | | | | | | | | | | | | | | | | | | | | | | | | | | | | | | | | | | | | | | | | | | | | | | | | | | | | | | | | | | | | | | | | | | | | | | | | | | | | | | | | | | | | | | | | | | | | | | | | | | | | | | | | | | | | | | | | | | | | | | | | | | | | | | | | | | | | | | | | | | | | | | | | | | | | | | | | | | | | | | | | | | | | | | | | | | | | | | | | | | | | | | | | | | | | | | | | | | | | | | | | | | | | | | | | | | | | | | | | | | | | | | | | | | | | | | | | | | | | | | | | | | | | | | | | | | | | | | | | | | | | | | | | | | | | | | | | | | | | | | | | | | | | | | | | | | | | | | | | | | | | | | | | | | | | | | | | | | | | | | | | | | | | | | | | | | | | | | | | | | | | | | | | | | | | | | | | | | | | | | | | | | | | | | | | | | | | | | | | | | | | | | | | | | | | | | | | | | | | | | | | | | | | | | | | | | | | | | | | | | | | | | | | | | | | | | | | | | | | | | | | | | | | | |
| 680 | | | | | | | | | | | | | | | | | | | | | | | | | | | | | | | | | | | | | | | | | | | | | | | | | | | | | | | | | | | | | | | | | | | | | | | | | | | | | | | | | | | | | | | | | | | | | | | | | | | | | | | | | | | | | | | | | | | | | | | | | | | | | | | | | | | | | | | | | | | | | | | | | | | | | | | | | | | | | | | | | | | | | | | | | | | | | | | | | | | | | | | | | | | | | | | | | | | | | | | | | | | | | | | | | | | | | | | | | | | | | | | | | | | | | | | | | | | | | | | | | | | | | | | | | | | | | | | | | | | | | | | | | | | | | | | | | | | | | | | | | | | | | | | | | | | | | | | | | | | | | | | | | | | | | | | | | | | | | | | | | | | | | | | | | | | | | | | | | | | | | | | | | | | | | | | | | | | | | | | | | | | | | | | | | | | | | | | | | | | | | | | | | | | | | | | | | | | | | | | | | | | | | | | | | | | | | | | | | | | | | | | | | | | | | | | | | | | | | | | | | | | | | | | | | | | | | | | | | | | | | | | | | | | | | | | | | | | | | | | | | | | | | | | | | | | | | | | | | | | | | | | | | | | | | | | | | | | | | | | | | | | | | | | | | | | | | | | | | | | | | | | | | | | | | | | | | | | | | | | | | | | | | | | | | | | | | | | | | | | | | | | | | | | | | | | | | | | | | | | | | | | | | | | | | | | | | | | | | | | | | | | | | | | | | | | | | | | | | | | | | | | | | | | | | | | | | | | | | | | | | | | | | | | | | | | | | | | | | | | | | | | | | | | | | | | | | | | | | | | | | | | | | | | | | | | | | | | | | | | | | | | | | | | | | | | | | | | | | | | | | | | | | | | | | | | | | | | | | | | | | | | | | | | | | | | | | | | | | | | | | | | | | | | | | | | | | | | | | | | | | | | | | | | | | | | | | | | | | | | | | | | | | | | | | | | | | | | | | | | | | | | | | | | | | | | | | | | | | | | | | | | | | | | | | | | | | | | | | | | | | | | | | | | | | | | | | | | | | | | | | | | | | | | | | | | | | | | | | | | | | | | | | | | | | | | | | | | | | | | | | | | | | | | | | | | | | | | | | | | | | | | | | | | | | | | | | | | | | | | | | | | | | | | | | | | | | | | | | | | | | | | | | | | | | | | | | | | | | | | | | | | | | | | | | | | | | | | | | | | | | | | | | | | | | | | | | | | | | | | | | | | | | | | | | | | |
| 820 | | | | | | | | | | | | | | | | | | | | | | | | | | | | | | | | | | | | | | | | | | | | | | | | | | | | | | | | | | | | | | | | | | | | | | | | | | | | | | | | | | | | | | | | | | | | | | | | | | | | | | | | | | | | | | | | | | | | | | | | | | | | | | | | | | | | | | | | | | | | | | | | | | | | | | | | | | | | | | | | | | | | | | | | | | | | | | | | | | | | | | | | | | | | | | | | | | | | | | | | | | | | | | | | | | | | | | | | | | | | | | | | | | | | | | | | | | | | | | | | | | | | | | | | | | | | | | | | | | | | | | | | | | | | | | | | | | | | | | | | | | | | | | | | | | | | | | | | | | | | | | | | | | | | | | | | | | | | | | | | | | | | | | | | | | | | | | | | | | | | | | | | | | | | | | | | | | | | | | | | | | | | | | | | | | | | | | | | | | | | | | | | | | | | | | | | | | | | | | | | | | | | | | | | | | | | | | | | | | | | | | | | | | | | | | | | | | | | | | | | | | | | | | | | | | | | | | | | | | | | | | | | | | | | | | | | | | | | | | | | | | | | | | | | | | | | | | | | | | | | | | | | | | | | | | | | | | | | | | | | | | | | | | | | | | | | | | | | | | | | | | | | | | | | | | | | | | | | | | | | | | | | | | | | | | | | | | | | | | | | | | | | | | | | | | | | | | | | | | | | | | | | | | | | | | | | | | | | | | | | | | | | | | | | | | | | | | | | | | | | | | | | | | | | | | | | | | | | | | | | | | | | | | | | | | | | | | | | | | | | | | | | | | | | | | | | | | | | | | | | | | | | | | | | | | | | | | | | | | | | | | | | | | | | | | | | | | | | | | | | | | | | | | | | | | | | | | | | | | | | | | | | | | | | | | | | | | | | | | | | | | | | | | | | | | | | | | | | | | | | | | | | | | | | | | | | | | | | | | | | | | | | | | | | | | | | | | | | | | | | | | | | | | | | | | | | | | | | | | | | | | | | | | | | | | | | | | | | | | | | | | | | | | | | | | | | | | | | | | | | | | | | | | | | | | | | | | | | | | | | | | | | | | | | | | | | | | | | | | | | | | | | | | | | | | | | | | | | | | | | | | | | | | | | | | | | | | | | | | | | | | | | | | | | | | | | | | | | | | | | | | | | | | | | | | | | | | | | | | | | | | | | | | | | | | | | | | | | | | | | | | | | | | | | | | | | | | | | | | | | | | | | | | | | | | | |
| 1000 | | | | | | | | | | | | | | | | | | | | | | | | | | | | | | | | | | | | | | | | | | | | | | | | | | | | | | | | | | | | | | | | | | | | | | | | | | | | | | | | | | | | | | | | | | | | | | | | | | | | | | | | | | | | | | | | | | | | | | | | | | | | | | | | | | | | | | | | | | | | | | | | | | | | | | | | | | | | | | | | | | | | | | | | | | | | | | | | | | | | | | | | | | | | | | | | | | | | | | | | | | | | | | | | | | | | | | | | | | | | | | | | | | | | | | | | | | | | | | | | | | | | | | | | | | | | | | | | | | | | | | | | | | | | | | | | | | | | | | | | | | | | | | | | | | | | | | | | | | | | | | | | | | | | | | | | | | | | | | | | | | | | | | | | | | | | | | | | | | | | | | | | | | | | | | | | | | | | | | | | | | | | | | | | | | | | | | | | | | | | | | | | | | | | | | | | | | | | | | | | | | | | | | | | | | | | | | | | | | | | | | | | | | | | | | | | | | | | | | | | | | | | | | | | | | | | | | | | | | | | | | | | | | | | | | | | | | | | | | | | | | | | | | | | | | | | | | | | | | | | | | | | | | | | | | | | | | | | | | | | | | | | | | | | | | | | | | | | | | | | | | | | | | | | | | | | | | | | | | | | | | | | | | | | | | | | | | | | | | | | | | | | | | | | | | | | | | | | | | | | | | | | | | | | | | | | | | | | | | | | | | | | | | | | | | | | | | | | | | | | | | | | | | | | | | | | | | | | | | | | | | | | | | | | | | | | | | | | | | | | | | | | | | | | | | | | | | | | | | | | | | | | | | | | | | | | | | | | | | | | | | | | | | | | | | | | | | | | | | | | | | | | | | | | | | | | | | | | | | | | | | | | | | | | | | | | | | | | | | | | | | | | | | | | | | | | | | | | | | | | | | | | | | | | | | | | | | | | | | | | | | | | | | | | | | | | | | | | | | | | | | | | | | | | | | | | | | | | | | | | | | | | | | | | | | | | | | | | | | | | | | | | | | | | | | | | | | | | | | | | | | | | | | | | | | | | | | | | | | | | | | | | | | | | | | | | | | | | | | | | | | | | | | | | | | | | | | | | | | | | | | | | | | | | | | | | | | | | | | | | | | | | | | | | | | | | | | | | | | | | | | | | | | | | | | | | | | | | | | | | | | | | | | | | | | | | | | | | | | | | | | | | | | | | | | | | | | | | | | | | | | | | | | | | | | | |
| 1200 | | | | | | | | | | | | | | | | | | | | | | | | | | | | | | | | | | | | | | | | | | | | | | | | | | | | | | | | | | | | | | | | | | | | | | | | | | | | | | | | | | | | | | | | | | | | | | | | | | | | | | | | | | | | | | | | | | | | | | | | | | | | | | | | | | | | | | | | | | | | | | | | | | | | | | | | | | | | | | | | | | | | | | | | | | | | | | | | | | | | | | | | | | | | | | | | | | | | | | | | | | | | | | | | | | | | | | | | | | | | | | | | | | | | | | | | | | | | | | | | | | | | | | | | | | | | | | | | | | | | | | | | | | | | | | | | | | | | | | | | | | | | | | | | | | | | | | | | | | | | | | | | | | | | | | | | | | | | | | | | | | | | | | | | | | | | | | | | | | | | | | | | | | | | | | | | | | | | | | | | | | | | | | | | | | | | | | | | | | | | | | | | | | | | | | | | | | | | | | | | | | | | | | | | | | | | | | | | | | | | | | | | | | | | | | | | | | | | | | | | | | | | | | | | | | | | | | | | | | | | | | | | | | | | | | | | | | | | | | | | | | | | | | | | | | | | | | | | | | | | | | | | | | | | | | | | | | | | | | | | | | | | | | | | | | | | | | | | | | | | | | | | | | | | | | | | | | | | | | | | | | | | | | | | | | | | | | | | | | | | | | | | | | | | | | | | | | | | | | | | | | | | | | | | | | | | | | | | | | | | | | | | | | | | | | | | | | | | | | | | | | | | | | | | | | | | | | | | | | | | | | | | | | | | | | | | | | | | | | | | | | | | | | | | | | | | | | | | | | | | | | | | | | | | | | | | | | | | | | | | | | | | | | | | | | | | | | | | | | | | | | | | | | | | | | | | | | | | | | | | | | | | | | | | | | | | | | | | | | | | | | | | | | | | | | | | | | | | | | | | | | | | | | | | | | | | | | | | | | | | | | | | | | | | | | | | | | | | | | | | | | | | | | | | | | | | | | | | | | | | | | | | | | | | | | | | | | | | | | | | | | | | | | | | | | | | | | | | | | | | | | | | | | | | | | | | | | | | | | | | | | | | | | | | | | | | | | | | | | | | | | | | | | | | | | | | | | | | | | | | | | | | | | | | | | | | | | | | | | | | | | | | | | | | | | | | | | | | | | | | | | | | | | | | | | | | | | | | | | | | | | | | | | | | | | | | | | | | | | | | | | | | | | | | | | | | | | | | | | | | | | | | | | | | | | | |
| 1500 | | | | | | | | | | | | | | | | | | | | | | | | | | | | | | | | | | | | | | | | | | | | | | | | | | | | | | | | | | | | | | | | | | | | | | | | | | | | | | | | | | | | | | | | | | | | | | | | | | | | | | | | | | | | | | | | | | | | | | | | | | | | | | | | | | | | | | | | | | | | | | | | | | | | | | | | | | | | | | | | | | | | | | | | | | | | | | | | | | | | | | | | | | | | | | | | | | | | | | | | | | | | | | | | | | | | | | | | | | | | | | | | | | | | | | | | | | | | | | | | | | | | | | | | | | | | | | | | | | | | | | | | | | | | | | | | | | | | | | | | | | | | | | | | | | | | | | | | | | | | | | | | | | | | | | | | | | | | | | | | | | | | | | | | | | | | | | | | | | | | | | | | | | | | | | | | | | | | | | | | | | | | | | | | | | | | | | | | | | | | | | | | | | | | | | | | | | | | | | | | | | | | | | | | | | | | | | | | | | | | | | | | | | | | | | | | | | | | | | | | | | | | | | | | | | | | | | | | | | | | | | | | | | | | | | | | | | | | | | | | | | | | | | | | | | | | | | | | | | | | | | | | | | | | | | | | | | | | | | | | | | | | | | | | | | | | | | | | | | | | | | | | | | | | | | | | | | | | | | | | | | | | | | | | | | | | | | | | | | | | | | | | | | | | | | | | | | | | | | | | | | | | | | | | | | | | | | | | | | | | | | | | | | | | | | | | | | | | | | | | | | | | | | | | | | | | | | | | | | | | | | | | | | | | | | | | | | | | | | | | | | | | | | | | | | | | | | | | | | | | | | | | | | | | | | | | | | | | | | | | | | | | | | | | | | | | | | | | | | | | | | | | | | | | | | | | | | | | | | | | | | | | | | | | | | | | | | | | | | | | | | | | | | | | | | | | | | | | | | | | | | | | | | | | | | | | | | | | | | | | | | | | | | | | | | | | | | | | | | | | | | | | | | | | | | | | | | | | | | | | | | | | | | | | | | | | | | | | | | | | | | | | | | | | | | | | | | | | | | | | | | | | | | | | | | | | | | | | | | | | | | | | | | | | | | | | | | | | | | | | | | | | | | | | | | | | | | | | | | | | | | | | | | | | | | | | | | | | | | | | | | | | | | | | | | | | | | | | | | | | | | | | | | | | | | | | | | | | | | | | | | | | | | | | | | | | | | | | | | | | | | | | | | | | | | | | | | | | | | | | | | | | | | | | | | | |
| 1800 | | | | | | | | | | | | | | | | | | | | | | | | | | | | | | | | | | | | | | | | | | | | | | | | | | | | | | | | | | | | | | | | | | | | | | | | | | | | | | | | | | | | | | | | | | | | | | | | | | | | | | | | | | | | | | | | | | | | | | | | | | | | | | | | | | | | | | | | | | | | | | | | | | | | | | | | | | | | | | | | | | | | | | | | | | | | | | | | | | | | | | | | | | | | | | | | | | | | | | | | | | | | | | | | | | | | | | | | | | | | | | | | | | | | | | | | | | | | | | | | | | | | | | | | | | | | | | | | | | | | | | | | | | | | | | | | | | | | | | | | | | | | | | | | | | | | | | | | | | | | | | | | | | | | | | | | | | | | | | | | | | | | | | | | | | | | | | | | | | | | | | | | | | | | | | | | | | | | | | | | | | | | | | | | | | | | | | | | | | | | | | | | | | | | | | | | | | | | | | | | | | | | | | | | | | | | | | | | | | | | | | | | | | | | | | | | | | | | | | | | | | | | | | | | | | | | | | | | | | | | | | | | | | | | | | | | | | | | | | | | | | | | | | | | | | | | | | | | | | | | | | | | | | | | | | | | | | | | | | | | | | | | | | | | | | | | | | | | | | | | | | | | | | | | | | | | | | | | | | | | | | | | | | | | | | | | | | | | | | | | | | | | | | | | | | | | | | | | | | | | | | | | | | | | | | | | | | | | | | | | | | | | | | | | | | | | | | | | | | | | | | | | | | | | | | | | | | | | | | | | | | | | | | | | | | | | | | | | | | | | | | | | | | | | | | | | | | | | | | | | | | | | | | | | | | | | | | | | | | | | | | | | | | | | | | | | | | | | | | | | | | | | | | | | | | | | | | | | | | | | | | | | | | | | | | | | | | | | | | | | | | | | | | | | | | | | | | | | | | | | | | | | | | | | | | | | | | | | | | | | | | | | | | | | | | | | | | | | | | | | | | | | | | | | | | | | | | | | | | | | | | | | | | | | | | | | | | | | | | | | | | | | | | | | | | | | | | | | | | | | | | | | | | | | | | | | | | | | | | | | | | | | | | | | | | | | | | | | | | | | | | | | | | | | | | | | | | | | | | | | | | | | | | | | | | | | | | | | | | | | | | | | | | | | | | | | | | | | | | | | | | | | | | | | | | | | | | | | | | | | | | | | | | | | | | | | | | | | | | | | | | | | | | | | | | | | | | | | | | | | | | | | | | | | | | | |
| 2200 | | | | | | | | | | | | | | | | | | | | | | | | | | | | | | | | | | | | | | | | | | | | | | | | | | | | | | | | | | | | | | | | | | | | | | | | | | | | | | | | | | | | | | | | | | | | | | | | | | | | | | | | | | | | | | | | | | | | | | | | | | | | | | | | | | | | | | | | | | | | | | | | | | | | | | | | | | | | | | | | | | | | | | | | | | | | | | | | | | | | | | | | | | | | | | | | | | | | | | | | | | | | | | | | | | | | | | | | | | | | | | | | | | | | | | | | | | | | | | | | | | | | | | | | | | | | | | | | | | | | | | | | | | | | | | | | | | | | | | | | | | | | | | | | | | | | | | | | | | | | | | | | | | | | | | | | | | | | | | | | | | | | | | | | | | | | | | | | | | | | | | | | | | | | | | | | | | | | | | | | | | | | | | | | | | | | | | | | | | | | | | | | | | | | | | | | | | | | | | | | | | | | | | | | | | | | | | | | | | | | | | | | | | | | | | | | | | | | | | | | | | | | | | | | | | | | | | | | | | | | | | | | | | | | | | | | | | | | | | | | | | | | | | | | | | | | | | | | | | | | | | | | | | | | | | | | | | | | | | | | | | | | | | | | | | | | | | | | | | | | | | | | | | | | | | | | | | | | | | | | | | | | | | | | | | | | | | | | | | | | | | | | | | | | | | | | | | | | | | | | | | | | | | | | | | | | | | | | | | | | | | | | | | | | | | | | | | | | | | | | | | | | | | | | | | | | | | | | | | | | | | | | | | | | | | | | | | | | | | | | | | | | | | | | | | | | | | | | | | | | | | | | | | | | | | | | | | | | | | | | | | | | | | | | | | | | | | | | | | | | | | | | | | | | | | | | | | | | | | | | | | | | | | | | | | | | | | | | | | | | | | | | | | | | | | | | | | | | | | | | | | | | | | | | | | | | | | | | | | | | | | | | | | | | | | | | | | | | | | | | | | | | | | | | | | | | | | | | | | | | | | | | | | | | | | | | | | | | | | | | | | | | | | | | | | | | | | | | | | | | | | | | | | | | | | | | | | | | | | | | | | | | | | | | | | | | | | | | | | | | | | | | | | | | | | | | | | | | | | | | | | | | | | | | | | | | | | | | | | | | | | | | | | | | | | | | | | | | | | | | | | | | | | | | | | | | | | | | | | | | | | | | | | | | | | | | | | | | | | | | | | | | | | | | | | | | | | | | | | | | | | | | | | | | | | | |
| 2700 | | | | | | | | | | | | | | | | | | | | | | | | | | | | | | | | | | | | | | | | | | | | | | | | | | | | | | | | | | | | | | | | | | | | | | | | | | | | | | | | | | | | | | | | | | | | | | | | | | | | | | | | | | | | | | | | | | | | | | | | | | | | | | | | | | | | | | | | | | | | | | | | | | | | | | | | | | | | | | | | | | | | | | | | | | | | | | | | | | | | | | | | | | | | | | | | | | | | | | | | | | | | | | | | | | | | | | | | | | | | | | | | | | | | | | | | | | | | | | | | | | | | | | | | | | | | | | | | | | | | | | | | | | | | | | | | | | | | | | | | | | | | | | | | | | | | | | | | | | | | | | | | | | | | | | | | | | | | | | | | | | | | | | | | | | | | | | | | | | | | | | | | | | | | | | | | | | | | | | | | | | | | | | | | | | | | | | | | | | | | | | | | | | | | | | | | | | | | | | | | | | | | | | | | | | | | | | | | | | | | | | | | | | | | | | | | | | | | | | | | | | | | | | | | | | | | | | | | | | | | | | | | | | | | | | | | | | | | | | | | | | | | | | | | | | | | | | | | | | | | | | | | | | | | | | | | | | | | | | | | | | | | | | | | | | | | | | | | | | | | | | | | | | | | | | | | | | | | | | | | | | | | | | | | | | | | | | | | | | | | | | | | | | | | | | | | | | | | | | | | | | | | | | | | | | | | | | | | | | | | | | | | | | | | | | | | | | | | | | | | | | | | | | | | | | | | | | | | | | | | | | | | | | | | | | | | | | | | | | | | | | | | | | | | | | | | | | | | | | | | | | | | | | | | | | | | | | | | | | | | | | | | | | | | | | | | | | | | | | | | | | | | | | | | | | | | | | | | | | | | | | | | | | | | | | | | | | | | | | | | | | | | | | | | | | | | | | | | | | | | | | | | | | | | | | | | | | | | | | | | | | | | | | | | | | | | | | | | | | | | | | | | | | | | | | | | | | | | | | | | | | | | | | | | | | | | | | | | | | | | | | | | | | | | | | | | | | | | | | | | | | | | | | | | | | | | | | | | | | | | | | | | | | | | | | | | | | | | | | | | | | | | | | | | | | | | | | | | | | | | | | | | | | | | | | | | | | | | | | | | | | | | | | | | | | | | | | | | | | | | | | | | | | | | | | | | | | | | | | | | | | | | | | | | | | | | | | | | | | | | | | | | | | | | | | | | | | | | | | | | | | | | | | | | | | | |
| 3300 | | | | | | | | | | | | | | | | | | | | | | | | | | | | | | | | | | | | | | | | | | | | | | | | | | | | | | | | | | | | | | | | | | | | | | | | | | | | | | | | | | | | | | | | | | | | | | | | | | | | | | | | | | | | | | | | | | | | | | | | | | | | | | | | | | | | | | | | | | | | | | | | | | | | | | | | | | | | | | | | | | | | | | | | | | | | | | | | | | | | | | | | | | | | | | | | | | | | | | | | | | | | | | | | | | | | | | | | | | | | | | | | | | | | | | | | | | | | | | | | | | | | | | | | | | | | | | | | | | | | | | | | | | | | | | | | | | | | | | | | | | | | | | | | | | | | | | | | | | | | | | | | | | | | | | | | | | | | | | | | | | | | | | | | | | | | | | | | | | | | | | | | | | | | | | | | | | | | | | | | | | | | | | | | | | | | | | | | | | | | | | | | | | | | | | | | | | | | | | | | | | | | | | | | | | | | | | | | | | | | | | | | | | | | | | | | | | | | | | | | | | | | | | | | | | | | | | | | | | | | | | | | | | | | | | | | | | | | | | | | | | | | | | | | | | | | | | | | | | | | | | | | | | | | | | | | | | | | | | | | | | | | | | | | | | | | | | | | | | | | | | | | | | | | | | | | | | | | | | | | | | | | | | | | | | | | | | | | | | | | | | | | | | | | | | | | | | | | | | | | | | | | | | | | | | | | | | | | | | | | | | | | | | | | | | | | | | | | | | | | | | | | | | | | | | | | | | | | | | | | | | | | | | | | | | | | | | | | | | | | | | | | | | | | | | | | | | | | | | | | | | | | | | | | | | | | | | | | | | | | | | | | | | | | | | | | | | | | | | | | | | | | | | | | | | | | | | | | | | | | | | | | | | | | | | | | | | | | | | | | | | | | | | | | | | | | | | | | | | | | | | | | | | | | | | | | | | | | | | | | | | | | | | | | | | | | | | | | | | | | | | | | | | | | | | | | | | | | | | | | | | | | | | | | | | | | | | | | | | | | | | | | | | | | | | | | | | | | | | | | | | | | | | | | | | | | | | | | | | | | | | | | | | | | | | | | | | | | | | | | | | | | | | | | | | | | | | | | | | | | | | | | | | | | | | | | | | | | | | | | | | | | | | | | | | | | | | | | | | | | | | | | | | | | | | | | | | | | | | | | | | | | | | | | | | | | | | | | | | | | | | | | | | | | | | | | | | | | | | | | | | | | | | | | | | | |
| 3900 | | | | | | | | | | | | | | | | | | | | | | | | | | | | | | | | | | | | | | | | | | | | | | | | | | | | | | | | | | | | | | | | | | | | | | | | | | | | | | | | | | | | | | | | | | | | | | | | | | | | | | | | | | | | | | | | | | | | | | | | | | | | | | | | | | | | | | | | | | | | | | | | | | | | | | | | | | | | | | | | | | | | | | | | | | | | | | | | | | | | | | | | | | | | | | | | | | | | | | | | | | | | | | | | | | | | | | | | | | | | | | | | | | | | | | | | | | | | | | | | | | | | | | | | | | | | | | | | | | | | | | | | | | | | | | | | | | | | | | | | | | | | | | | | | | | | | | | | | | | | | | | | | | | | | | | | | | | | | | | | | | | | | | | | | | | | | | | | | | | | | | | | | | | | | | | | | | | | | | | | | | | | | | | | | | | | | | | | | | | | | | | | | | | | | | | | | | | | | | | | | | | | | | | | | | | | | | | | | | | | | | | | | | | | | | | | | | | | | | | | | | | | | | | | | | | | | | | | | | | | | | | | | | | | | | | | | | | | | | | | | | | | | | | | | | | | | | | | | | | | | | | | | | | | | | | | | | | | | | | | | | | | | | | | | | | | | | | | | | | | | | | | | | | | | | | | | | | | | | | | | | | | | | | | | | | | | | | | | | | | | | | | | | | | | | | | | | | | | | | | | | | | | | | | | | | | | | | | | | | | | | | | | | | | | | | | | | | | | | | | | | | | | | | | | | | | | | | | | | | | | | | | | | | | | | | | | | | | | | | | | | | | | | | | | | | | | | | | | | | | | | | | | | | | | | | | | | | | | | | | | | | | | | | | | | | | | | | | | | | | | | | | | | | | | | | | | | | | | | | | | | | | | | | | | | | | | | | | | | | | | | | | | | | | | | | | | | | | | | | | | | | | | | | | | | | | | | | | | | | | | | | | | | | | | | | | | | | | | | | | | | | | | | | | | | | | | | | | | | | | | | | | | | | | | | | | | | | | | | | | | | | | | | | | | | | | | | | | | | | | | | | | | | | | | | | | | | | | | | | | | | | | | | | | | | | | | | | | | | | | | | | | | | | | | | | | | | | | | | | | | | | | | | | | | | | | | | | | | | | | | | | | | | | | | | | | | | | | | | | | | | | | | | | | | | | | | | | | | | | | | | | | | | | | | | | | | | | | | | | | | | | | | | | | | | | | | | | | | | | | | | | | | | | | | | | |
| 4700 | | | | | | | | | | | | | | | | | | | | | | | | | | | | | | | | | | | | | | | | | | | | | | | | | | | | | | | | | | | | | | | | | | | | | | | | | | | | | | | | | | | | | | | | | | | | | | | | | | | | | | | | | | | | | | | | | | | | | | | | | | | | | | | | | | | | | | | | | | | | | | | | | | | | | | | | | | | | | | | | | | | | | | | | | | | | | | | | | | | | | | | | | | | | | | | | | | | | | | | | | | | | | | | | | | | | | | | | | | | | | | | | | | | | | | | | | | | | | | | | | | | | | | | | | | | | | | | | | | | | | | | | | | | | | | | | | | | | | | | | | | | | | | | | | | | | | | | | | | | | | | | | | | | | | | | | | | | | | | | | | | | | | | | | | | | | | | | | | | | | | | | | | | | | | | | | | | | | | | | | | | | | | | | | | | | | | | | | | | | | | | | | | | | | | | | | | | | | | | | | | | | | | | | | | | | | | | | | | | | | | | | | | | | | | | | | | | | | | | | | | | | | | | | | | | | | | | | | | | | | | | | | | | | | | | | | | | | | | | | | | | | | | | | | | | | | | | | | | | | | | | | | | | | | | | | | | | | | | | | | | | | | | | | | | | | | | | | | | | | | | | | | | | | | | | | | | | | | | | | | | | | | | | | | | | | | | | | | | | | | | | | | | | | | | | | | | | | | | | | | | | | | | | | | | | | | | | | | | | | | | | | | | | | | | | | | | | | | | | | | | | | | | | | | | | | | | | | | | | | | | | | | | | | | | | | | | | | | | | | | | | | | | | | | | | | | | | | | | | | | | | | | | | | | | | | | | | | | | | | | | | | | | | | | | | | | | | | | | | | | | | | | | | | | | | | | | | | | | | | | | | | | | | | | | | | | | | | | | | | | | | | | | | | | | | | | | | | | | | | | | | | | | | | | | | | | | | | | | | | | | | | | | | | | | | | | | | | | | | | | | | | | | | | | | | | | | | | | | | | | | | | | | | | | | | | | | | | | | | | | | | | | | | | | | | | | | | | | | | | | | | | | | | | | | | | | | | | | | | | | | | | | | | | | | | | | | | | | | | | | | | | | | | | | | | | | | | | | | | | | | | | | | | | | | | | | | | | | | | | | | | | | | | | | | | | | | | | | | | | | | | | | | | | | | | | | | | | | | | | | | | | | | | | | | | | | | | | | | | | | | | | | | | | | | | | | | | | | | | | | | | | | | | | | | | | |
| 5600 | | | | | | | | | | | | | | | | | | | | | | | | | | | | | | | | | | | | | | | | | | | | | | | | | | | | | | | | | | | | | | | | | | | | | | | | | | | | | | | | | | | | | | | | | | | | | | | | | | | | | | | | | | | | | | | | | | | | | | | | | | | | | | | | | | | | | | | | | | | | | | | | | | | | | | | | | | | | | | | | | | | | | | | | | | | | | | | | | | | | | | | | | | | | | | | | | | | | | | | | | | | | | | | | | | | | | | | | | | | | | | | | | | | | | | | | | | | | | | | | | | | | | | | | | | | | | | | | | | | | | | | | | | | | | | | | | | | | | | | | | | | | | | | | | | | | | | | | | | | | | | | | | | | | | | | | | | | | | | | | | | | | | | | | | | | | | | | | | | | | | | | | | | | | | | | | | | | | | | | | | | | | | | | | | | | | | | | | | | | | | | | | | | | | | | | | | | | | | | | | | | | | | | | | | | | | | | | | | | | | | | | | | | | | | | | | | | | | | | | | | | | | | | | | | | | | | | | | | | | | | | | | | | | | | | | | | | | | | | | | | | | | | | | | | | | | | | | | | | | | | | | | | | | | | | | | | | | | | | | | | | | | | | | | | | | | | | | | | | | | | | | | | | | | | | | | | | | | | | | | | | | | | | | | | | | | | | | | | | | | | | | | | | | | | | | | | | | | | | | | | | | | | | | | | | | | | | | | | | | | | | | | | | | | | | | | | | | | | | | | | | | | | | | | | | | | | | | | | | | | | | | | | | | | | | | | | | | | | | | | | | | | | | | | | | | | | | | | | | | | | | | | | | | | | | | | | | | | | | | | | | | | | | | | | | | | | | | | | | | | | | | | | | | | | | | | | | | | | | | | | | | | | | | | | | | | | | | | | | | | | | | | | | | | | | | | | | | | | | | | | | | | | | | | | | | | | | | | | | | | | | | | | | | | | | | | | | | | | | | | | | | | | | | | | | | | | | | | | | | | | | | | | | | | | | | | | | | | | | | | | | | | | | | | | | | | | | | | | | | | | | | | | | | | | | | | | | | | | | | | | | | | | | | | | | | | | | | | | | | | | | | | | | | | | | | | | | | | | | | | | | | | | | | | | | | | | | | | | | | | | | | | | | | | | | | | | | | | | | | | | | | | | | | | | | | | | | | | | | | | | | | | | | | | | | | | | | | | | | | | | | | | | | | | | | | | | | | | | | | | | | | | | | | | | | | |
| 6800 | | | | | | | | | | | | | | | | | | | | | | | | | | | | | | | | | | | | | | | | | | | | | | | | | | | | | | | | | | | | | | | | | | | | | | | | | | | | | | | | | | | | | | | | | | | | | | | | | | | | | | | | | | | | | | | | | | | | | | | | | | | | | | | | | | | | | | | | | | | | | | | | | | | | | | | | | | | | | | | | | | | | | | | | | | | | | | | | | | | | | | | | | | | | | | | | | | | | | | | | | | | | | | | | | | | | | | | | | | | | | | | | | | | | | | | | | | | | | | | | | | | | | | | | | | | | | | | | | | | | | | | | | | | | | | | | | | | | | | | | | | | | | | | | | | | | | | | | | | | | | | | | | | | | | | | | | | | | | | | | | | | | | | | | | | | | | | | | | | | | | | | | | | | | | | | | | | | | | | | | | | | | | | | | | | | | | | | | | | | | | | | | | | | | | | | | | | | | | | | | | | | | | | | | | | | | | | | | | | | | | | | | | | | | | | | | | | | | | | | | | | | | | | | | | | | | | | | | | | | | | | | | | | | | | | | | | | | | | | | | | | | | | | | | | | | | | | | | | | | | | | | | | | | | | | | | | | | | | | | | | | | | | | | | | | | | | | | | | | | | | | | | | | | | | | | | | | | | | | | | | | | | | | | | | | | | | | | | | | | | | | | | | | | | | | | | | | | | | | | | | | | | | | | | | | | | | | | | | | | | | | | | | | | | | | | | | | | | | | | | | | | | | | | | | | | | | | | | | | | | | | | | | | | | | | | | | | | | | | | | | | | | | | | | | | | | | | | | | | | | | | | | | | | | | | | | | | | | | | | | | | | | | | | | | | | | | | | | | | | | | | | | | | | | | | | | | | | | | | | | | | | | | | | | | | | | | | | | | | | | | | | | | | | | | | | | | | | | | | | | | | | | | | | | | | | | | | | | | | | | | | | | | | | | | | | | | | | | | | | | | | | | | | | | | | | | | | | | | | | | | | | | | | | | | | | | | | | | | | | | | | | | | | | | | | | | | | | | | | | | | | | | | | | | | | | | | | | | | | | | | | | | | | | | | | | | | | | | | | | | | | | | | | | | | | | | | | | | | | | | | | | | | | | | | | | | | | | | | | | | | | | | | | | | | | | | | | | | | | | | | | | | | | | | | | | | | | | | | | | | | | | | | | | | | | | | | | | | | | | | | | | | | | | | | | | | | | | | | | | | | | | | | | | | | | | |
| 8200 | | | | | | | | | | | | | | | | | | | | | | | | | | | | | | | | | | | | | | | | | | | | | | | | | | | | | | | | | | | | | | | | | | | | | | | | | | | | | | | | | | | | | | | | | | | | | | | | | | | | | | | | | | | | | | | | | | | | | | | | | | | | | | | | | | | | | | | | | | | | | | | | | | | | | | | | | | | | | | | | | | | | | | | | | | | | | | | | | | | | | | | | | | | | | | | | | | | | | | | | | | | | | | | | | | | | | | | | | | | | | | | | | | | | | | | | | | | | | | | | | | | | | | | | | | | | | | | | | | | | | | | | | | | | | | | | | | | | | | | | | | | | | | | | | | | | | | | | | | | | | | | | | | | | | | | | | | | | | | | | | | | | | | | | | | | | | | | | | | | | | | | | | | | | | | | | | | | | | | | | | | | | | | | | | | | | | | | | | | | | | | | | | | | | | | | | | | | | | | | | | | | | | | | | | | | | | | | | | | | | | | | | | | | | | | | | | | | | | | | | | | | | | | | | | | | | | | | | | | | | | | | | | | | | | | | | | | | | | | | | | | | | | | | | | | | | | | | | | | | | | | | | | | | | | | | | | | | | | | | | | | | | | | | | | | | | | | | | | | | | | | | | | | | | | | | | | | | | | | | | | | | | | | | | | | | | | | | | | | | | | | | | | | | | | | | | | | | | | | | | | | | | | | | | | | | | | | | | | | | | | | | | | | | | | | | | | | | | | | | | | | | | | | | | | | | | | | | | | | | | | | | | | | | | | | | | | | | | | | | | | | | | | | | | | | | | | | | | | | | | | | | | | | | | | | | | | | | | | | | | | | | | | | | | | | | | | | | | | | | | | | | | | | | | | | | | | | | | | | | | | | | | | | | | | | | | | | | | | | | | | | | | | | | | | | | | | | | | | | | | | | | | | | | | | | | | | | | | | | | | | | | | | | | | | | | | | | | | | | | | | | | | | | | | | | | | | | | | | | | | | | | | | | | | | | | | | | | | | | | | | | | | | | | | | | | | | | | | | | | | | | | | | | | | | | | | | | | | | | | | | | | | | | | | | | | | | | | | | | | | | | | | | | | | | | | | | | | | | | | | | | | | | | | | | | | | | | | | | | | | | | | | | | | | | | | | | | | | | | | | | | | | | | | | | | | | | | | | | | | | | | | | | | | | | | | | | | | | | | | | | | | | | | | | | | | | | | | | | | | | | | | | | | | | | | | |
| 10000 | | | | | | | | | | | | | | | | | | | | | | | | | | | | | | | | | | | | | | | | | | | | | | | | | | | | | | | | | | | | | | | | | | | | | | | | | | | | | | | | | | | | | | | | | | | | | | | | | | | | | | | | | | | | | | | | | | | | | | | | | | | | | | | | | | | | | | | | | | | | | | | | | | | | | | | | | | | | | | | | | | | | | | | | | | | | | | | | | | | | | | | | | | | | | | | | | | | | | | | | | | | | | | | | | | | | | | | | | | | | | | | | | | | | | | | | | | | | | | | | | | | | | | | | | | | | | | | | | | | | | | | | | | | | | | | | | | | | | | | | | | | | | | | | | | | | | | | | | | | | | | | | | | | | | | | | | | | | | | | | | | | | | | | | | | | | | | | | | | | | | | | | | | | | | | | | | | | | | | | | | | | | | | | | | | | | | | | | | | | | | | | | | | | | | | | | | | | | | | | | | | | | | | | | | | | | | | | | | | | | | | | | | | | | | | | | | | | | | | | | | | | | | | | | | | | | | | | | | | | | | | | | | | | | | | | | | | | | | | | | | | | | | | | | | | | | | | | | | | | | | | | | | | | | | | | | | | | | | | | | | | | | | | | | | | | | | | | | | | | | | | | | | | | | | | | | | | | | | | | | | | | | | | | | | | | | | | | | | | | | | | | | | | | | | | | | | | | | | | | | | | | | | | | | | | | | | | | | | | | | | | | | | | | | | | | | | | | | | | | | | | | | | | | | | | | | | | | | | | | | | | | | | | | | | | | | | | | | | | | | | | | | | | | | | | | | | | | | | | | | | | | | | | | | | | | | | | | | | | | | | | | | | | | | | | | | | | | | | | | | | | | | | | | | | | | | | | | | | | | | | | | | | | | | | | | | | | | | | | | | | | | | | | | | | | | | | | | | | | | | | | | | | | | | | | | | | | | | | | | | | | | | | | | | | | | | | | | | | | | | | | | | | | | | | | | | | | | | | | | | | | | | | | | | | | | | | | | | | | | | | | | | | | | | | | | | | | | | | | | | | | | | | | | | | | | | | | | | | | | | | | | | | | | | | | | | | | | | | | | | | | | | | | | | | | | | | | | | | | | | | | | | | | | | | | | | | | | | | | | | | | | | | | | | | | | | | | | | | | | | | | | | | | | | | | | | | | | | | | | | | | | | | | | | | | | | | | | | | | | | | | | | | | | | | | | | | | | | | | | | | | | | | | | | | | | |

*Reflow soldering only.

NOTES: For higher voltage chips, see pages 20 and 21.

= Paper Tape
 = Embossed Tape

COG (NP0) Dielectric



Capacitance Range

PREFERRED SIZES ARE SHADED

| SIZE | | 1210 | | | | 1808* | | | 1812* | | | | 1825* | | | 2220* | | | 2225* | | |
|-------------------------|----------------------|-----------------------------|----|-----|-----|-----------------------------|-----|-----|-----------------------------|----|-----|-----|-----------------------------|-----|-----|----------------------------|-----|-----|-----------------------------|-----|-----|
| Standard Reel Packaging | | Paper/Embossed | | | | All Embossed | | | All Embossed | | | | All Embossed | | | All Embossed | | | All Embossed | | |
| (L) Length | MM (in.) | 3.20 ± .20 (.126 ± .008) | | | | 4.57 ± .25 (.180 ± .010) | | | 4.50 ± .30 (.177 ± .012) | | | | 4.50 ± .30 (.177 ± .012) | | | 5.7 ± .40 (.225 ± .016) | | | 5.72 ± .25 (.225 ± .010) | | |
| (W) Width | MM (in.) | 2.50 ± .20 (.098 ± .008) | | | | 2.03 ± .25 (.080 ± .010) | | | 3.20 ± .20 (.126 ± .008) | | | | 6.40 ± .40 (.252 ± .016) | | | 5.0 ± .40 (.197 ± .016) | | | 6.35 ± .25 (.250 ± .010) | | |
| (T) Max. Thickness | MM (in.) | 1.70 (.067) | | | | 1.52 (.060) | | | 1.70 (.067) | | | | 1.70 (.067) | | | 2.30 (.090) | | | 1.70 (.067) | | |
| (t) Terminal | MM (in.) | .50 ± .25 (.020 ± .010) | | | | .64 ± .39 (.025 ± .015) | | | .61 ± .36 (.024 ± .014) | | | | .61 ± .36 (.024 ± .014) | | | .64 ± .39 (.025 ± .015) | | | .64 ± .39 (.025 ± .015) | | |
| WVDC | | 25 | 50 | 100 | 200 | 50 | 100 | 200 | 25 | 50 | 100 | 200 | 50 | 100 | 200 | 50 | 100 | 200 | 50 | 100 | 200 |
| Cap (pF) | 560 680 820 | | | | | | | | | | | | | | | | | | | | |
| | 1000 1200 1500 | | | | | | | | | | | | | | | | | | | | |
| | 1800 2200 2700 | | | | | | | | | | | | | | | | | | | | |
| | 3300 3900 4700 | | | | | | | | | | | | | | | | | | | | |
| | 5600 6800 8200 | | | | | | | | | | | | | | | | | | | | |
| Cap. (µF) | .010 .012 .015 | | | | | | | | | | | | | | | | | | | | |
| | .018 .022 .027 | | | | | | | | | | | | | | | | | | | | |
| | .033 .039 .047 | | | | | | | | | | | | | | | | | | | | |
| | .068 .082 .1 | | | | | | | | | | | | | | | | | | | | |

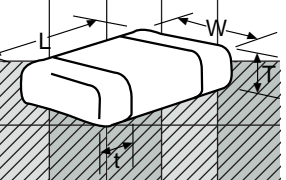

*Reflow soldering only.

NOTES: For higher voltage chips, see pages 20 and 21.

= Paper Tape
 = Embossed Tape

X7R Dielectric

General Specifications

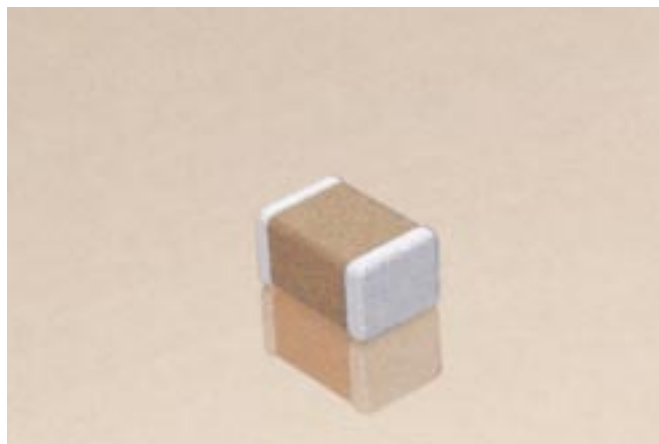

X7R formulations are called “temperature stable” ceramics and fall into EIA Class II materials. X7R is the most popular of these intermediate dielectric constant materials. Its temperature variation of capacitance is within $\pm 15\%$ from -55°C to $+125^{\circ}\text{C}$. This capacitance change is non-linear.

Capacitance for X7R varies under the influence of electrical operating conditions such as voltage and frequency.

X7R dielectric chip usage covers the broad spectrum of industrial applications where known changes in capacitance due to applied voltages are acceptable.

PART NUMBER (see page 3 for complete part number explanation)

0805

Size
(L" x W")

5

Voltage
10V = Z
16V = Y
25V = 3
50V = 5
100V = 1

C

Dielectric
X7R = C

103

Capacitance Code

M

Capacitance Tolerance
Preferred
M = $\pm 20\%$
K = $\pm 10\%$

A

Failure Rate
A = Not Applicable

T

Terminations
T = Plated Ni and Solder

2

Packaging
2 = 7" Reel
4 = 13" Reel

A

Special Code
A = Std. Product

PERFORMANCE CHARACTERISTICS

| | |
|---|--|
| Capacitance Range | 100 pF to 2.2 μF (1.0 ± 0.2 Vrms, 1kHz) |
| Capacitance Tolerances | Preferred $\pm 10\%$, $\pm 20\%$ others available: $\pm 5\%$, $+80 -20\%$ |
| Operating Temperature Range | -55°C to $+125^{\circ}\text{C}$ |
| Temperature Characteristic | $\pm 15\%$ (0 VDC) |
| Voltage Ratings | 10, 16, 25, 50, 100 VDC ($+125^{\circ}\text{C}$) |
| Dissipation Factor | For 50 volts and 100 volts: 2.5% max. For 25 volts: 3.0% max. For 16 volts: 3.5% max. For 10 volts: 5% max. |
| Insulation Resistance ($+25^{\circ}\text{C}$, RVDC) | 100,000 megohms min. or 1000 $\text{M}\Omega$ - μF min., whichever is less |
| Insulation Resistance ($+125^{\circ}\text{C}$, RVDC) | 10,000 megohms min. or 100 $\text{M}\Omega$ - μF min., whichever is less |
| Dielectric Strength | 250% of rated voltage for 5 seconds at 50 mamp max. current |
| Test Voltage | 1.0 ± 0.2 Vrms |
| Test Frequency | 1 KHz |

Typical Characteristic Curves**

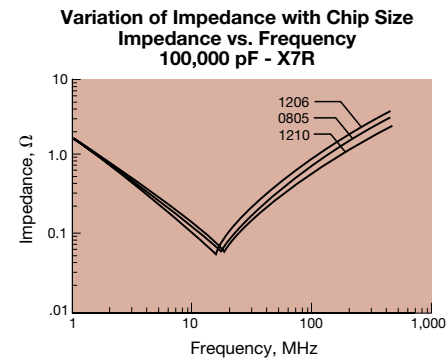
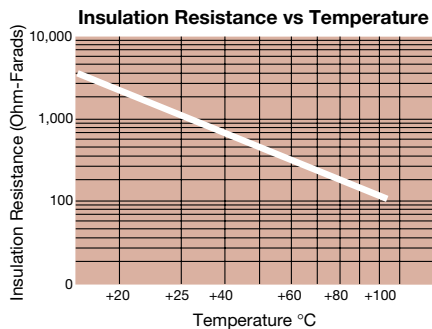
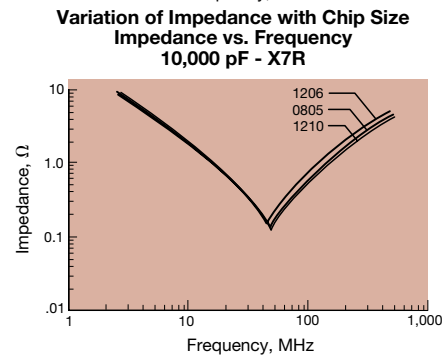
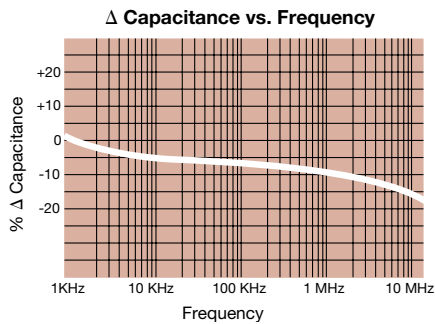
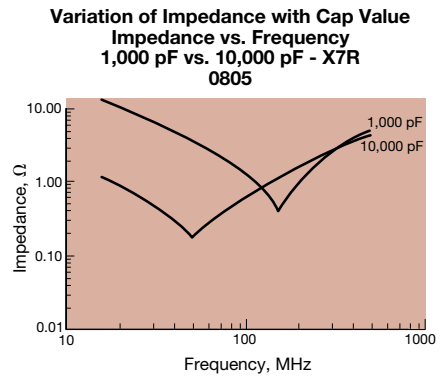
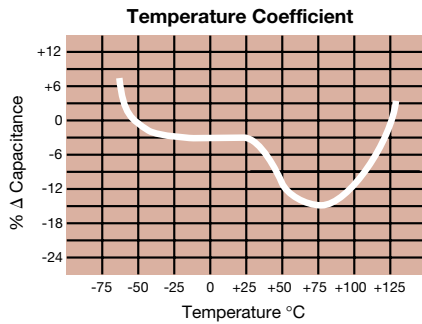

SUMMARY OF CAPACITANCE RANGES VS. CHIP SIZE

| Style | 10V | 16V | 25V | 50V | 100V |
|-------|---------------------------|----------------------|----------------------|---------------------|---------------------|
| 0402* | — | 100pF - 47nF | 100pF - 6.8nF | 100pF - 3.9nF | — |
| 0504 | — | — | — | 100pF - .01 μ F | 100pF - 3.3nF |
| 0603* | 100pF - 0.22 μ F | 100pF - 0.1 μ F | 100pF - 47nF | 100pF - 15nF | 100pF - 4.7nF |
| 0805* | 100pF - 2.2 μ F | 100pF - 0.47 μ F | 100pF - 0.22 μ F | 100pF - 0.1 μ F | 100pF - 22nF |
| 1206* | 1.5 μ F - 4.7 μ F | 1nF - 1 μ F | 1nF - 1.0 μ F | 1nF - 0.22 μ F | 1nF - 0.1 μ F |
| 1210* | → | 1nF - 1.8 μ F | 1nF - 1 μ F | 1nF - 0.22 μ F | 1nF - 0.1 μ F |
| 1505 | → | → | → | 1nF - 0.1 μ F | 1nF - 27nF |
| 1808 | → | → | 10nF - 0.33 μ F | 10nF - 0.33 μ F | 10nF - 0.1 μ F |
| 1812* | → | → | → | 10nF - 1 μ F | 10nF - 0.47 μ F |
| 1825* | → | → | → | 10nF - 1 μ F | 10nF - 0.47 μ F |
| 2220 | → | → | → | 10nF - 1.5 μ F | 10nF - 1.2 μ F |
| 2225 | → | → | → | 10nF - 2.2 μ F | 10nF - 1.5 μ F |

* Standard Sizes

** For additional information on performance changes with operating conditions consult AVX's software SpiCap.

X7R Dielectric

Capacitance Range



PREFERRED SIZES ARE SHADED

| SIZE | | 0402* | | | 0504* | | | 0603* | | | 0805 | | | 1206 | | | 1505 | | | | | | | | | | | | | | | | | | | | | | | | | | | | | | | | | | | | | | | | | | | | | | | | | | | | | | | | | | |
|-------------------------|-------------|---|------|------|-----------------------------|------|------|-----------------------------|------|------|-----------------------------|------|------|-----------------------------|------|------|-----------------------------|------|------|------|------|------|------|-----|-----|-----|-----|-----|-----|-----|-----|-----|-----|-----|------|------|------|------|------|------|------|------|------|------|------|------|------|------|------|------|------|------|------|------|------|------|------|------|-----|-----|-----|-----|-----|-----|-----|-----|-----|-----|-----|-----|-----|-----|-----|-----|-----|
| Standard Reel Packaging | | All Paper | | | All Embossed | | | All Paper | | | Paper/Embossed | | | Paper/Embossed | | | All Embossed | | | | | | | | | | | | | | | | | | | | | | | | | | | | | | | | | | | | | | | | | | | | | | | | | | | | | | | | | | |
| (L) Length | MM (in.) | 1.00 ± .10 (.040 ± .004) | | | 1.27 ± .25 (.050 ± .010) | | | 1.60 ± .15 (.063 ± .006) | | | 2.01 ± .20 (.079 ± .008) | | | 3.20 ± .20 (.126 ± .008) | | | 3.81 ± .25 (.150 ± .010) | | | | | | | | | | | | | | | | | | | | | | | | | | | | | | | | | | | | | | | | | | | | | | | | | | | | | | | | | | |
| (W) Width | MM (in.) | .50 ± .10 (.020 ± .004) | | | 1.02 ± .25 (.040 ± .010) | | | .81 ± .15 (.032 ± .006) | | | 1.25 ± .20 (.049 ± .008) | | | 1.60 ± .20 (.063 ± .008) | | | 1.27 ± .25 (.050 ± .010) | | | | | | | | | | | | | | | | | | | | | | | | | | | | | | | | | | | | | | | | | | | | | | | | | | | | | | | | | | |
| (T) Max. Thickness | MM (in.) | .60 (.024) | | | 1.02 (.040) | | | .90 (.035) | | | 1.30 (.051) | | | 1.50 (.059) | | | 1.27 (.050) | | | | | | | | | | | | | | | | | | | | | | | | | | | | | | | | | | | | | | | | | | | | | | | | | | | | | | | | | | |
| (t) Terminal | MM (in.) | .25 ± .15 (.010 ± .006) | | | .38 ± .13 (.015 ± .005) | | | .35 ± .15 (.014 ± .006) | | | .50 ± .25 (.020 ± .010) | | | .50 ± .25 (.020 ± .010) | | | .50 ± .25 (.020 ± .010) | | | | | | | | | | | | | | | | | | | | | | | | | | | | | | | | | | | | | | | | | | | | | | | | | | | | | | | | | | |
| WVDC | | 16 | 25 | 50 | 50 | 100 | 10 | 16 | 25 | 50 | 100 | 10 | 16 | 25 | 50 | 100 | 10 | 16 | 25 | 50 | 100 | 50 | 100 | | | | | | | | | | | | | | | | | | | | | | | | | | | | | | | | | | | | | | | | | | | | | | | | | | | | |
| Cap. (pF) | | | | | | | | | | | | | | | | | | | | | | | | | | | | | | | | | | | | | | | | | | | | | | | | | | | | | | | | | | | | | | | | | | | | | | | | | | | |
| | | <table border="1"> <tr><td>100</td><td>120</td><td>150</td><td>180</td><td>220</td><td>270</td><td>330</td><td>390</td><td>470</td><td>560</td><td>680</td><td>820</td><td>1000</td><td>1200</td><td>1500</td><td>1800</td><td>2200</td><td>2700</td><td>3300</td><td>3900</td><td>4700</td><td>5600</td><td>6800</td><td>8200</td></tr> <tr><td>.010</td><td>.012</td><td>.015</td><td>.018</td><td>.022</td><td>.027</td><td>.033</td><td>.039</td><td>.047</td><td>.056</td><td>.068</td><td>.082</td><td>.10</td><td>.12</td><td>.15</td><td>.18</td><td>.22</td><td>.27</td><td>.33</td><td>.47</td><td>.56</td><td>.68</td><td>.82</td><td>1.0</td><td>1.2</td><td>1.5</td><td>1.8</td><td>2.2</td><td>4.7</td></tr> </table> | | | | | | | | | | | | | | | | | | | | | 100 | 120 | 150 | 180 | 220 | 270 | 330 | 390 | 470 | 560 | 680 | 820 | 1000 | 1200 | 1500 | 1800 | 2200 | 2700 | 3300 | 3900 | 4700 | 5600 | 6800 | 8200 | .010 | .012 | .015 | .018 | .022 | .027 | .033 | .039 | .047 | .056 | .068 | .082 | .10 | .12 | .15 | .18 | .22 | .27 | .33 | .47 | .56 | .68 | .82 | 1.0 | 1.2 | 1.5 | 1.8 | 2.2 | 4.7 |
| 100 | 120 | 150 | 180 | 220 | 270 | 330 | 390 | 470 | 560 | 680 | 820 | 1000 | 1200 | 1500 | 1800 | 2200 | 2700 | 3300 | 3900 | 4700 | 5600 | 6800 | 8200 | | | | | | | | | | | | | | | | | | | | | | | | | | | | | | | | | | | | | | | | | | | | | | | | | | | | |
| .010 | .012 | .015 | .018 | .022 | .027 | .033 | .039 | .047 | .056 | .068 | .082 | .10 | .12 | .15 | .18 | .22 | .27 | .33 | .47 | .56 | .68 | .82 | 1.0 | 1.2 | 1.5 | 1.8 | 2.2 | 4.7 | | | | | | | | | | | | | | | | | | | | | | | | | | | | | | | | | | | | | | | | | | | | | | | |

*Reflow soldering only.

NOTES: For higher voltage chips, see pages 20 and 21.

= Paper Tape
 = Embossed Tape

X7R Dielectric



Capacitance Range

PREFERRED SIZES ARE SHADED

| SIZE | | 1210 | | | | 1808* | | | 1812* | | 1825* | | 2220* | | | 2225* | | | |
|-------------------------|-------------|-----------------------------|----|----|-----|-----------------------------|----|-----|-----------------------------|-----|-----------------------------|-----|----------------------------|-----|-----|-----------------------------|-----|--|--|
| Standard Reel Packaging | | Paper/Embossed | | | | All Embossed | | | All Embossed | | All Embossed | | All Embossed | | | All Embossed | | | |
| (L) Length | MM (in.) | 3.20 ± .20 (.126 ± .008) | | | | 4.57 ± .25 (.180 ± .010) | | | 4.50 ± .30 (.177 ± .012) | | 4.50 ± .30 (.177 ± .012) | | 5.7 ± 0.4 (.225 ± .016) | | | 5.72 ± .25 (.225 ± .010) | | | |
| (W) Width | MM (in.) | 2.50 ± .20 (.098 ± .008) | | | | 2.03 ± .25 (.080 ± .010) | | | 3.20 ± .20 (.126 ± .008) | | 6.40 ± .40 (.252 ± .016) | | 5.0 ± 0.4 (.197 ± .016) | | | 6.35 ± .25 (.250 ± .010) | | | |
| (T) Max. Thickness | MM (in.) | 1.70 (.067) | | | | 1.52 (.060) | | | 1.70 (.067) | | 1.70 (.067) | | 2.30 (.090) | | | 1.70 (.067) | | | |
| (t) Terminal | MM (in.) | .50 ± .25 (.020 ± .010) | | | | .64 ± .39 (.025 ± .015) | | | .61 ± .36 (.024 ± .014) | | .61 ± .36 (.024 ± .014) | | .64 ± .39 (.025 ± .015) | | | .64 ± .39 (.025 ± .015) | | | |
| WVDC | | 16 | 25 | 50 | 100 | 25 | 50 | 100 | 50 | 100 | 50 | 100 | 50 | 100 | 200 | 50 | 100 | | |
| Cap (pF) | 1000 | | | | | | | | | | | | | | | | | | |
| | 1200 | | | | | | | | | | | | | | | | | | |
| | 1500 | | | | | | | | | | | | | | | | | | |
| | 1800 | | | | | | | | | | | | | | | | | | |
| | 2200 | | | | | | | | | | | | | | | | | | |
| | 2700 | | | | | | | | | | | | | | | | | | |
| | 3300 | | | | | | | | | | | | | | | | | | |
| | 3900 | | | | | | | | | | | | | | | | | | |
| | 4700 | | | | | | | | | | | | | | | | | | |
| | 5600 | | | | | | | | | | | | | | | | | | |
| | 6800 | | | | | | | | | | | | | | | | | | |
| | 8200 | | | | | | | | | | | | | | | | | | |
| | Cap. (µF) | | | | | | | | | | | | | | | | | | |
| | .010 | | | | | | | | | | | | | | | | | | |
| | .012 | | | | | | | | | | | | | | | | | | |
| | .015 | | | | | | | | | | | | | | | | | | |
| | .018 | | | | | | | | | | | | | | | | | | |
| | .022 | | | | | | | | | | | | | | | | | | |
| | .027 | | | | | | | | | | | | | | | | | | |
| | .033 | | | | | | | | | | | | | | | | | | |
| | .039 | | | | | | | | | | | | | | | | | | |
| | .047 | | | | | | | | | | | | | | | | | | |
| | .056 | | | | | | | | | | | | | | | | | | |
| | .068 | | | | | | | | | | | | | | | | | | |
| | .082 | | | | | | | | | | | | | | | | | | |
| | .10 | | | | | | | | | | | | | | | | | | |
| | .12 | | | | | | | | | | | | | | | | | | |
| | .15 | | | | | | | | | | | | | | | | | | |
| | .18 | | | | | | | | | | | | | | | | | | |
| | .22 | | | | | | | | | | | | | | | | | | |
| | .27 | | | | | | | | | | | | | | | | | | |
| | .33 | | | | | | | | | | | | | | | | | | |
| | .39 | | | | | | | | | | | | | | | | | | |
| | .47 | | | | | | | | | | | | | | | | | | |
| | .56 | | | | | | | | | | | | | | | | | | |
| | .68 | | | | | | | | | | | | | | | | | | |
| | .82 | | | | | | | | | | | | | | | | | | |
| | 1.0 | | | | | | | | | | | | | | | | | | |
| | 1.2 | | | | | | | | | | | | | | | | | | |
| | 1.5 | | | | | | | | | | | | | | | | | | |
| | 1.8 | | | | | | | | | | | | | | | | | | |
| | 2.2 | | | | | | | | | | | | | | | | | | |

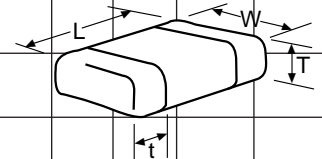

*Reflow soldering only.

NOTES: For higher voltage chips, see pages 20 and 21.

= Paper Tape
 = Embossed Tape

Z5U Dielectric

General Specifications



Z5U formulations are “general-purpose” ceramics which are meant primarily for use in limited temperature applications where small size and cost are important. Z5U show wide variations in capacitance under influence of environmental and electrical operating conditions.

Despite their capacitance instability, Z5U formulations are very popular because of their small size, low ESL, low ESR and excellent frequency response. These features are particularly important for decoupling application where only a minimum capacitance value is required.

PART NUMBER (see page 3 for complete part number explanation)

0805

Size
(L" x W")

5

Voltage
25V = 3
50V = 5

E

Dielectric
Z5U = E

104

Capacitance Code

Z

Capacitance Tolerance
Preferred
Z = +80%
-20%
M = ±20%

A

Failure Rate
A = Not
Applicable

T

Terminations
T = Plated Ni
and Solder

2

Packaging
2 = 7" Reel
4 = 13" Reel

A

Special Code
A = Std.
Product

PERFORMANCE CHARACTERISTICS

| | |
|--|--|
| Capacitance Range | 0.01 μ F to 1.0 μ F |
| Capacitance Tolerances | Preferred +80 -20% others available: \pm 20%, +100 -0% |
| Operating Temperature Range | +10°C to +85°C |
| Temperature Characteristic | +22% to -56% max. |
| Voltage Ratings | 25 and 50VDC (+85°C) |
| Dissipation Factor | 4% max. |
| Insulation Resistance (+25°C, RVDC) | 10,000 megohms min. or 1000 M Ω - μ F min., whichever is less |
| Dielectric Strength | 250% of rated voltage for 5 seconds at 50 mamp max. current |
| Test Voltage | 0.5 \pm 0.2 Vrms |
| Test Frequency | 1 KHz |

Typical Characteristic Curves**

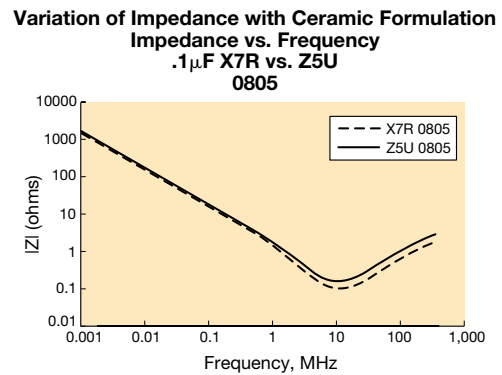
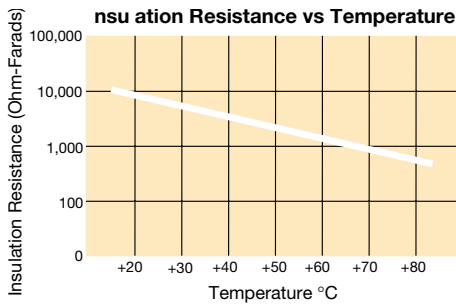
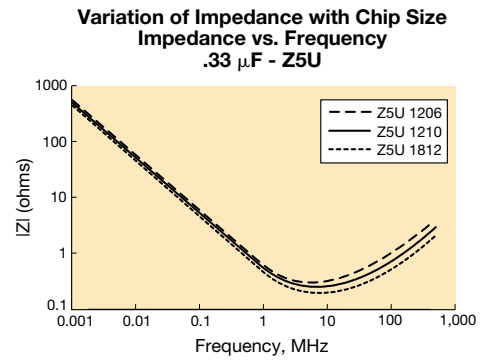
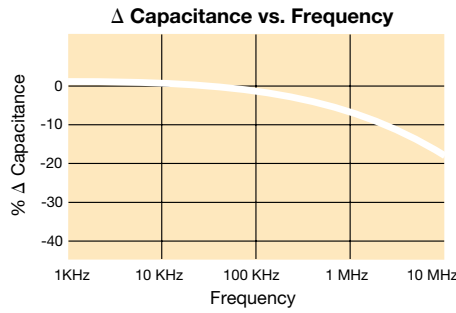
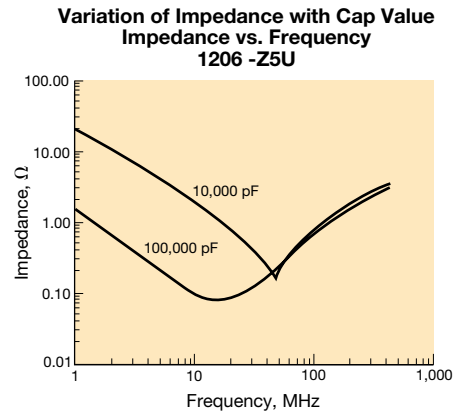
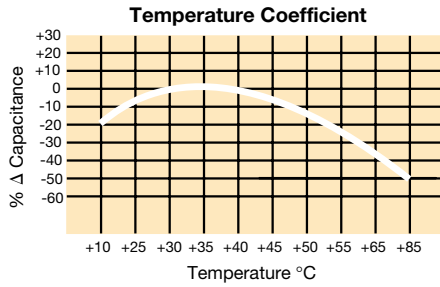

SUMMARY OF CAPACITANCE RANGES VS. CHIP SIZE

| Style | 25V | 50V |
|-------|----------------|----------------|
| 0603* | .01μF - .047μF | .01μF - .027μF |
| 0805* | .01μF - .12μF | .01μF - 0.1μF |
| 1206* | .01μF - .33μF | .01μF - .33μF |
| 1210* | .01μF - .56μF | .01μF - .47μF |
| 1808 | .01μF - .56μF | .01μF - .47μF |
| 1812* | .01μF - 1.0μF | .01μF - 1.0μF |
| 1825* | .01μF - 1.0μF | .01μF - 1.0μF |
| 2225 | .01μF - 1.0μF | .01μF - 1.0μF |

* Standard Sizes

** For additional information on performance changes with operating conditions consult AVX's software SpiCap.

Z5U Dielectric

Capacitance Range



PREFERRED SIZES ARE SHADED

| SIZE | □ | | □ | | □ | | □ | | |
|-------------------------|-------------|-----------------------------|-----------------------------|-----------------------------|-----------------------------|-----------------------------|-----------------------------|-----------------------------|----|
| | 0603* | | 0805 | | 1206 | | 1210 | | |
| Standard Reel Packaging | All Paper | | Paper/Embossed | | Paper/Embossed | | Paper/Embossed | | |
| (L) Length | MM (in.) | 1.60 ± .15 (.063 ± .006) | 2.01 ± .20 (.079 ± .008) | 3.20 ± .20 (.126 ± .008) | 3.20 ± .20 (.126 ± .008) | 3.20 ± .20 (.126 ± .008) | 3.20 ± .20 (.126 ± .008) | 3.20 ± .20 (.126 ± .008) | |
| (W) Width | MM (in.) | .81 ± .15 (.032 ± .006) | 1.25 ± .20 (.049 ± .008) | 1.60 ± .20 (.063 ± .008) | 1.60 ± .20 (.063 ± .008) | 1.60 ± .20 (.063 ± .008) | 2.50 ± .20 (.098 ± .008) | 2.50 ± .20 (.098 ± .008) | |
| (T) Max. Thickness | MM (in.) | .90 (.035) | 1.30 (.051) | 1.50 (.059) | 1.50 (.059) | 1.50 (.059) | 1.70 (.067) | 1.70 (.067) | |
| (t) Terminal | MM (in.) | .35 ± .15 (.014 ± .006) | .50 ± .25 (.020 ± .010) | .50 ± .25 (.020 ± .010) | .50 ± .25 (.020 ± .010) | .50 ± .25 (.020 ± .010) | .50 ± .25 (.020 ± .010) | .50 ± .25 (.020 ± .010) | |
| WDC | | 25 | 50 | 25 | 50 | 25 | 50 | 25 | 50 |
| Cap (µF) | | | | | | | | | |
| | .010 | | | | | | | | |
| | .012 | | | | | | | | |
| | .015 | | | | | | | | |
| | .018 | | | | | | | | |
| | .022 | | | | | | | | |
| | .027 | | | | | | | | |
| | .033 | | | | | | | | |
| | .039 | | | | | | | | |
| | .047 | | | | | | | | |
| | .056 | | | | | | | | |
| | .068 | | | | | | | | |
| | .082 | | | | | | | | |
| | .10 | | | | | | | | |
| | .12 | | | | | | | | |
| | .15 | | | | | | | | |
| | .18 | | | | | | | | |
| | .22 | | | | | | | | |
| | .27 | | | | | | | | |
| | .33 | | | | | | | | |
| | .39 | | | | | | | | |
| | .47 | | | | | | | | |
| | .56 | | | | | | | | |
| | .68 | | | | | | | | |
| | .82 | | | | | | | | |
| | 1.0 | | | | | | | | |
| | 1.5 | | | | | | | | |

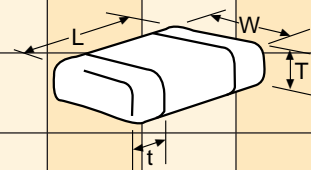

*Reflow soldering only.

□ = Paper Tape
 ▨ = Embossed Tape





NOTES: For low profile chips, see page 19.

Z5U Dielectric

Capacitance Range



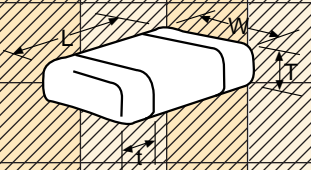
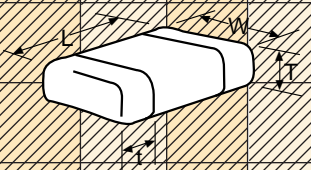
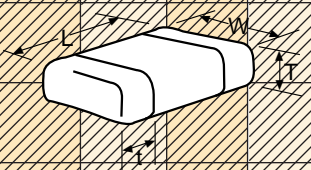
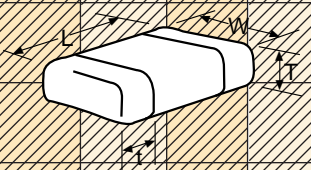

PREFERRED SIZES ARE SHADED

| | |  | |  | |  | |  | |
|-------------------------|-------------|--|----|--|----|---|----|---|----|
| SIZE | | 1808* | | 1812* | | 1825* | | 2225* | |
| Standard Reel Packaging | | All Embossed | | All Embossed | | All Embossed | | All Embossed | |
| (L) Length | MM (in.) | 04.57 ± .25 (.180 ± .010) | | 4.50 ± .30 (.177 ± .012) | | 4.50 ± .30 (.177 ± .012) | | 5.72 ± .25 (.225 ± .010) | |
| (W) Width | MM (in.) | 2.03 ± .25 (.080 ± .010) | | 3.20 ± .20 (.126 ± .008) | | 6.40 ± .40 (.252 ± .016) | | 6.35 ± .25 (.250 ± .010) | |
| (T) Max. Thickness | MM (in.) | 1.52 (.060) | | 1.70 (.067) | | 1.70 (.067) | | 1.70 (.067) | |
| (t) Terminal | MM (in.) | .64 ± .39 (.025 ± .015) | | .61 ± .36 (.024 ± .014) | | .61 ± .36 (.024 ± .014) | | .64 ± .39 (.025 ± .015) | |
| WVDC | | 25 | 50 | 25 | 50 | 25 | 50 | 25 | 50 |
| Cap | .010 |  | |  | |  | |  | |
| (μF) | .012 | | | | | | | | |
| | .015 | | | | | | | | |
| | .018 | | | | | | | | |
| | .022 | | | | | | | | |
| | .027 | | | | | | | | |
| | .033 | | | | | | | | |
| | .039 | | | | | | | | |
| | .047 | | | | | | | | |
| | .056 | | | | | | | | |
| | .068 | | | | | | | | |
| | .082 | | | | | | | | |
| | .10 | | | | | | | | |
| | .12 | | | | | | | | |
| | .15 | | | | | | | | |
| | .18 | | | | | | | | |
| | .22 | | | | | | | | |
| | .27 | | | | | | | | |
| | .33 | | | | | | | | |
| | .39 | | | | | | | | |
| | .47 | | | | | | | | |
| | .56 | | | | | | | | |
| | .68 | | | | | | | | |
| | .82 | | | | | | | | |
| | 1.0 | | | | | | | | |
| | 1.5 | | | | | | | | |

*Reflow soldering only.

NOTES: For low profile chips, see page 19.

 = Paper Tape
 = Embossed Tape

Y5V Dielectric



General Specifications

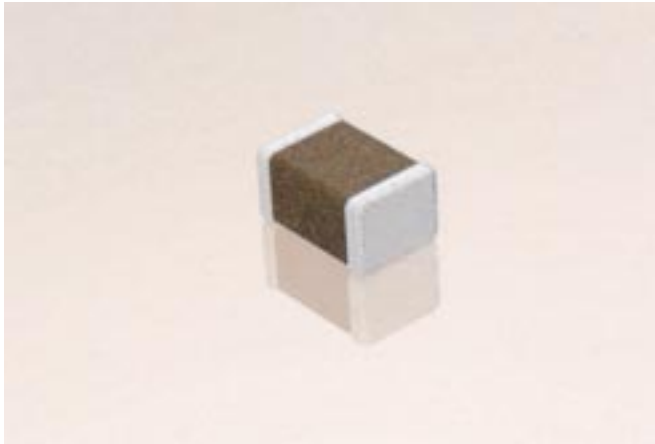

Y5V formulations are for general-purpose use in a limited temperature range. They have a wide temperature characteristic of +22% –82% capacitance change over the operating temperature range of –30°C to +85°C.

Y5V's high dielectric constant allows the manufacture of the highest capacitance value in a given case size.

These characteristics make Y5V ideal for decoupling applications within limited temperature range.

PART NUMBER (see page 3 for complete part number explanation)

0805

Size
(L" x W")

3

Voltage
10V = Z
16V = Y
25V = 3
50V = 5

G

Dielectric
Y5V = G

104

Capacitance
Code

Z

Capacitance
Tolerance
Z = +80 –20%

A

Failure
Rate
A = Not
Applicable

T

Terminations
T = Plated Ni
and Solder

2

Packaging
2 = 7" Reel
4 = 13" Reel

A

Special
Code
A = Std.
Product

PERFORMANCE CHARACTERISTICS

| | |
|--|---|
| Capacitance Range | 2200 pF to 22 μ F |
| Capacitance Tolerances | +80 –20% |
| Operating Temperature Range | –30°C to +85°C |
| Temperature Characteristic | +22% to –82% max. within operating temperature |
| Voltage Ratings | 10, 16, 25 and 50 VDC (+85°C) |
| Dissipation Factor | For 50 volts: 5.0% max. For 16 and 25 volts: 7% max. For 10 volts: 10% max. |
| Insulation Resistance (+25°C, RVDC) | 10,000 megohms min. or 1000 M Ω - μ F min., whichever is less |
| Dielectric Strength | 250% of rated voltage for 5 seconds at 50 mamp max. current |
| Test Voltage | 1.0 Vrms \pm 0.2 Vrms |
| Test Frequency | 1 KHz |

Typical Characteristic Curves**

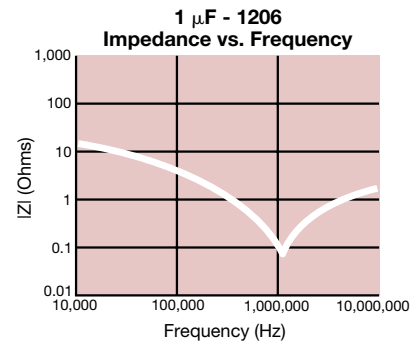
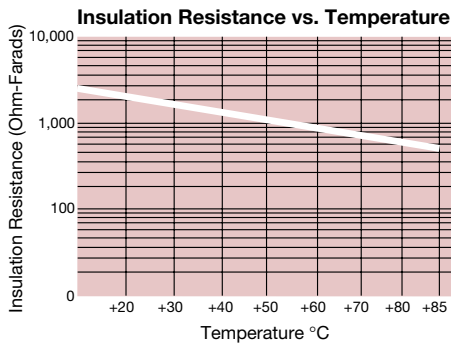
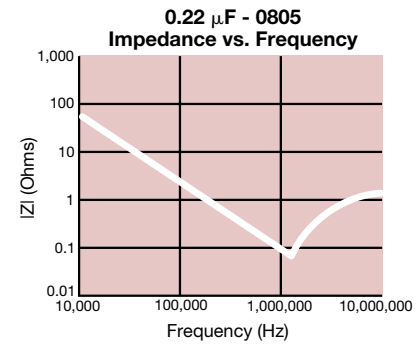
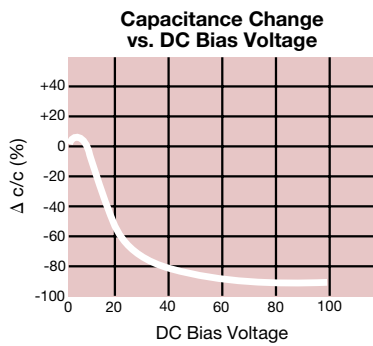
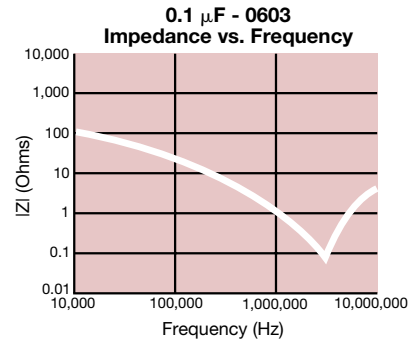
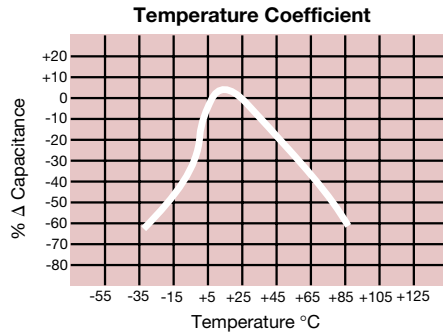

SUMMARY OF CAPACITANCE RANGES VS. CHIP SIZE

| Style | 10V | 16V | 25V | 50V |
|-------|---------------|----------------|----------------|----------------|
| 0402* | 2.2nF - 0.1μF | 2.2nF - 0.1μF | 2.2nF - 22nF | 2.2nF - 10nF |
| 0603* | 2.2nF - 1μF | 2.2nF - 0.33μF | 2.2nF - 0.22μF | 2.2nF - 56nF |
| 0805* | 10nF - 4.7μF | 10nF - 2.2μF | 10nF - 1μF | 10nF - 0.33μF |
| 1206* | 10nF - 10μF | 10nF - 4.7μF | 10nF - 2.2μF | 10nF - 1μF |
| 1210* | 10nF - 22μF | 0.1μF - 10μF | 0.1μF - 4.7μF | 0.1μF - 1μF |
| 1812* | → | → | 0.15μF - 1.5μF | 1.5nF - 1.5μF |
| 1825* | → | → | 0.47μF - 1.5μF | 0.47μF - 1.5μF |
| 2220 | — | — | — | 1μF - 1.5μF |
| 2225 | → | → | 0.68μF - 2.2μF | 0.68μF - 1.5μF |

* Standard Sizes

** For additional information on performance changes with operating conditions consult AVX's software SpiCap.

Y5V Dielectric

Capacitance Range



PREFERRED SIZES ARE SHADED

| SIZE | 0402* | | 0603* | | 0805 | | 1206 | | 1210 | | 1812* | | 1825* | | 2220* | | 2225* | |
|--------------------|----------------------|-----------------------------|-----------------------------|-----------------------------|-----------------------------|-----------------------------|-----------------------------|-----------------------------|----------------------------|-----------------------------|-----------------------------|-----------------------------|-----------------------------|-----------------------------|-----------------------------|-----------------------------|-----------------------------|-----------------------------|
| | All Paper | | All Paper | | Paper/Embossed | | Paper/Embossed | | Paper/Embossed | | All Embossed | | All Embossed | | All Embossed | | All Embossed | |
| (L) Length | MM (in.) | 1.00 ± .10 (.040 ± .004) | 1.60 ± .15 (.063 ± .006) | 2.01 ± .20 (.079 ± .008) | 3.20 ± .20 (.126 ± .008) | 3.20 ± .20 (.126 ± .008) | 4.50 ± .30 (.177 ± .012) | 4.50 ± .30 (.177 ± .012) | 5.7 ± 0.4 (.225 ± .016) | 5.7 ± 0.4 (.225 ± .016) | 5.72 ± .25 (.225 ± .010) | 5.72 ± .25 (.225 ± .010) | 5.72 ± .25 (.225 ± .010) | 5.72 ± .25 (.225 ± .010) | 5.72 ± .25 (.225 ± .010) | 5.72 ± .25 (.225 ± .010) | 5.72 ± .25 (.225 ± .010) | 5.72 ± .25 (.225 ± .010) |
| (W) Width | MM (in.) | .50 ± .10 (.020 ± .004) | .81 ± .15 (.032 ± .006) | 1.25 ± .20 (.049 ± .008) | 1.60 ± .20 (.063 ± .008) | 2.50 ± .20 (.098 ± .008) | 3.20 ± .20 (.126 ± .008) | 6.40 ± .40 (.252 ± .016) | 5.0 ± 0.4 (.197 ± .016) | 6.35 ± .25 (.250 ± .010) | 6.35 ± .25 (.250 ± .010) | 6.35 ± .25 (.250 ± .010) | 6.35 ± .25 (.250 ± .010) | 6.35 ± .25 (.250 ± .010) | 6.35 ± .25 (.250 ± .010) | 6.35 ± .25 (.250 ± .010) | 6.35 ± .25 (.250 ± .010) | 6.35 ± .25 (.250 ± .010) |
| (T) Max. Thickness | MM (in.) | .60 (.024) | .90 (.035) | 1.30 (.051) | 1.50 (.059) | 1.70 (.067) | 1.70 (.067) | 2.30 (.090) | 2.30 (.090) | 2.30 (.090) | 2.30 (.090) | 2.30 (.090) | 2.30 (.090) | 2.30 (.090) | 2.30 (.090) | 2.30 (.090) | 2.30 (.090) | 2.30 (.090) |
| (t) Terminal | MM (in.) | .25 ± .15 (.010 ± .006) | .35 ± .15 (.014 ± .006) | .50 ± .25 (.020 ± .010) | .50 ± .25 (.020 ± .010) | .50 ± .25 (.020 ± .010) | .61 ± .36 (.024 ± .014) | .61 ± .36 (.024 ± .014) | .64 ± .39 (.025 ± .015) | .64 ± .39 (.025 ± .015) | .64 ± .39 (.025 ± .015) | .64 ± .39 (.025 ± .015) | .64 ± .39 (.025 ± .015) | .64 ± .39 (.025 ± .015) | .64 ± .39 (.025 ± .015) | .64 ± .39 (.025 ± .015) | .64 ± .39 (.025 ± .015) | .64 ± .39 (.025 ± .015) |
| WVDC | | 10 16 25 50 | 10 16 25 50 | 10 16 25 50 | 10 16 25 50 | 10 16 25 50 | 25 50 | 25 50 | 25 50 | 25 50 | 25 50 | 25 50 | 25 50 | 25 50 | 25 50 | 25 50 | 25 50 | 25 50 |
| Cap (pF) | 2200 2700 3300 | | | | | | | | | | | | | | | | | |
| | 3900 4700 5600 | | | | | | | | | | | | | | | | | |
| | 6800 8200 | | | | | | | | | | | | | | | | | |
| Cap (µF) | .01 .012 .015 | | | | | | | | | | | | | | | | | |
| | .018 .022 .027 | | | | | | | | | | | | | | | | | |
| | .033 .039 .047 | | | | | | | | | | | | | | | | | |
| | .056 .068 .082 | | | | | | | | | | | | | | | | | |
| | .10 .12 .15 | | | | | | | | | | | | | | | | | |
| | .18 .22 .27 | | | | | | | | | | | | | | | | | |
| | .33 .39 .47 | | | | | | | | | | | | | | | | | |
| | .56 .68 .82 | | | | | | | | | | | | | | | | | |
| | 1.0 1.2 1.5 | | | | | | | | | | | | | | | | | |
| | 1.8 2.2 2.7 | | | | | | | | | | | | | | | | | |
| | 3.3 3.9 4.7 | | | | | | | | | | | | | | | | | |
| | 5.6 6.8 8.2 | | | | | | | | | | | | | | | | | |
| | 10.0 12.0 15.0 | | | | | | | | | | | | | | | | | |
| | 18.0 22.0 | | | | | | | | | | | | | | | | | |

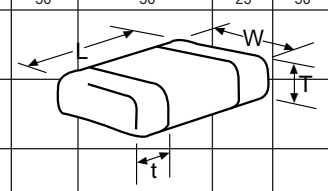

*Reflow soldering only.

NOTES: For low profile product, see page 19.

= Paper Tape
 = Embossed Tape

Low Profile Chips



Z5U & Y5V Dielectric

PART NUMBER (see page 3 for complete information and options)

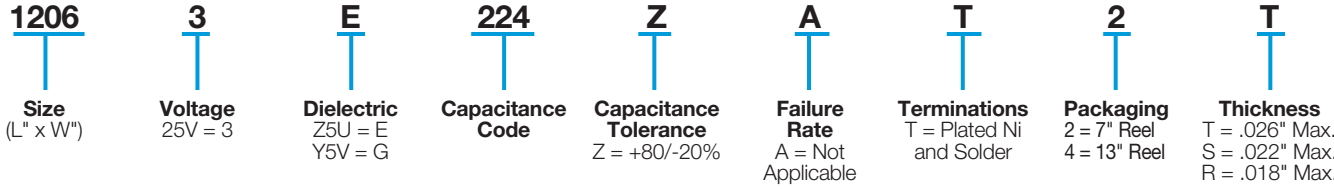

PERFORMANCE CHARACTERISTICS

| | |
|--|---|
| Capacitance Range | Z5U: .01 – .33µF; Y5V: .01 – .47µF |
| Capacitance Tolerances | +80, -20% |
| Operating Temperature Range | Z5U: +10°C to +85°C; Y5V: -30°C to +85°C |
| Temperature Characteristic | Z5U: +22%, -56%; Y5V: +22%, -82% |
| Voltage Ratings | 25 VDC |
| Dissipation Factor 25°C, .5 Vrms, 1kHz | Z5U: 4%; Y5V: 7% |
| Insulation Resistance | 10,000 megohms min. or 1000 MΩ - µF whichever is less |
| Dielectric Strength for 5 seconds at 50 mamp max. current | 250% of rated VDC |
| Test Voltage | Z5U: 0.5 ± 0.2 Vrms Y5V: 1.0 Vrms ± 0.2 Vrms |
| Test Frequency | 1 KHz |

CAPACITANCE VALUES FOR VARIOUS THICKNESSES

Z5U

| SIZE | 0805 | | | 1206 | | | 1210 | | |
|--------------------|---|------------|------------|-------------------------|------------|------------|-------------------------|------------|------------|
| (L) Length | MM (in.) 2.01 ± .20 (.079 ± .008) | | | 3.2 ± .2 (.126 ± .008) | | | 3.2 ± .2 (.126 ± .008) | | |
| (W) Width | 1.25 ± .20 (.049 ± .008) | | | 1.6 ± .2 (.063 ± .008) | | | 2.5 ± .2 (.098 ± .008) | | |
| (t) Terminal | .50 ± .25 (.020 ± .010) | | | .50 ± .25 (.020 ± .010) | | | .50 ± .25 (.020 ± .010) | | |
| (T) Thickness Max. | .46 (.018) | .56 (.022) | .66 (.026) | .46 (.018) | .56 (.022) | .66 (.026) | .46 (.018) | .56 (.022) | .66 (.026) |
| Cap (µF) | .01, .012, .015, .018, .022, .027, .033, .039, .047, .056, .068, .082, .1, .12, .15, .18, .22, .27, .33, .39, .47 | | | | | | | | |

Y5V

| SIZE | 0805 | | | 1206 | | | 1210 | | |
|--------------------|---|------------|------------|-------------------------|------------|------------|-------------------------|------------|------------|
| (L) Length | MM (in.) 2.01 ± .20 (.079 ± .008) | | | 3.2 ± .2 (.126 ± .008) | | | 3.2 ± .2 (.126 ± .008) | | |
| (W) Width | 1.25 ± .20 (.049 ± .008) | | | 1.6 ± .2 (.063 ± .008) | | | 2.5 ± .2 (.098 ± .008) | | |
| (t) Terminal | .50 ± .25 (.020 ± .010) | | | .50 ± .25 (.020 ± .010) | | | .50 ± .25 (.020 ± .010) | | |
| (T) Thickness Max. | .46 (.018) | .56 (.022) | .66 (.026) | .46 (.018) | .56 (.022) | .66 (.026) | .46 (.018) | .56 (.022) | .66 (.026) |
| Cap (µF) | .01, .012, .015, .018, .022, .027, .033, .039, .047, .056, .068, .082, .1, .12, .15, .18, .22, .27, .33, .39, .47 | | | | | | | | |

= Paper Tape

= Paper Tape



High Voltage Chips

For 500V to 5000V Applications

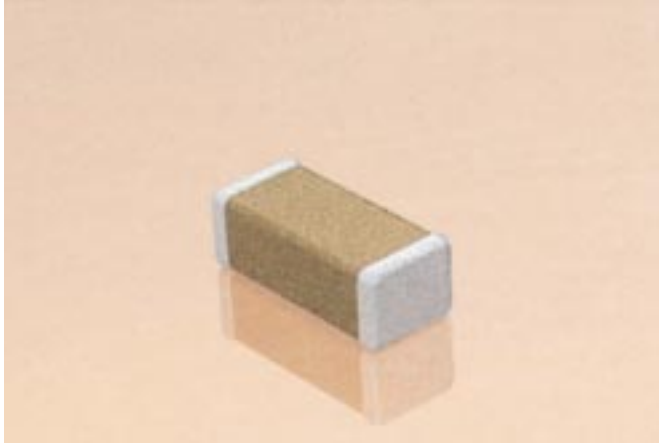

High value, low leakage and small size are difficult parameters to obtain in capacitors for high voltage systems. AVX special high voltage MLC chips capacitors meet these performance characteristics and are designed for applications such as snubbers in high frequency power converters, resonators in SMPS, and high voltage coupling/DC blocking. These high voltage chip designs exhibit low ESRs at high frequencies.

High voltage chips are typically larger than standard voltage rated chips. These larger sizes require that special precautions be taken in applying these chips in surface mount assemblies. This is due to differences in the coefficient of thermal expansion (CTE) between the substrate materials and chip capacitors.

PART NUMBER (see page 3 for complete information and options)

| | | | | | | | | |
|--|---|--------------------------------|--|--|---------------------|-------------------------------------|---|---------------------|
| 1808 | A | A | 271 | K | A | 1 | 1 | A |
| | | | | | | | | |
| AVX Style | Voltage | Temperature Coefficient | Capacitance Code | Capacitance Tolerance | Failure Rate | Termination | Packaging | Special Code |
| 1206 1210 1808 1812 1825 2225 3640 | 500V = 7 600V = C 1000V = A 1500V = S 2000V = G 2500V = W 3000V = H 4000V = J 5000V = K | COG = A X7R = C | (2 significant digits + no. of zeros) Examples: 10pF = 100 100pF = 101 1,000pF = 102 22,000pF = 223 220,000pF = 224 1µF = 105 | COG: J= ±5% K= ±10% M= ±20% X7R: K= ±10% M= ±20% Z= +80% - 20% | A=Not applicable | 1= Pd/Ag T= Plated Ni and Solder | 1 = 7" Reel Embossed Tape 3 = 13" Reel Embossed Tape 9 = Bulk | A = Standard |



High Voltage Chips



For 500V to 5000V Applications

C0G (NP0) Dielectric

PERFORMANCE CHARACTERISTICS

| | |
|--|---|
| Capacitance Range | 100 pF to .047 μ F (25°C, 1.0 \pm 0.2 Vrms at 1kHz) |
| Capacitance Tolerances | \pm 5%, \pm 10%, \pm 20% |
| Dissipation Factor | 0.1% max. (+25°C, 1.0 \pm 0.2 Vrms, 1kHz) |
| Operating Temperature Range | -55°C to +125°C |
| Temperature Characteristic | 0 \pm 30 ppm/°C (0 VDC) |
| Voltage Ratings | 500, 600, 1000, 1500, 2000, 2500, 3000, 4000 & 5000 VDC (+125°C) |
| Insulation Resistance (+25°C, at 500 VDC) | 100,000 megohms min. or 1000 M Ω - μ F min., whichever is less |
| Insulation Resistance (+125°C, at 500 VDC) | 10,000 megohms min. or 100 M Ω - μ F min., whichever is less |
| Dielectric Strength | 120% rated voltage for 5 seconds at 50 mamp max. current |
| Thickness | Dependent upon size, voltage, and capacitance value |

C0G (NP0) MAXIMUM CAPACITANCE VALUES

| VOLTAGE | 1206 | 1210 | 1808 | 1812 | 1825 | 2225 | 3640 |
|---------|--------|---------|---------|---------|--------------|--------------|--------------|
| 500 | 680 pF | 1500 pF | 3300 pF | 5600 pF | .012 μ F | .018 μ F | — |
| 600 | 680 pF | 1500 pF | 3300 pF | 5600 pF | .012 μ F | .018 μ F | .047 μ F |
| 1000 | 330 pF | 680 pF | 1500 pF | 2200 pF | 5600 pF | 8200 pF | .018 μ F |
| 1500 | 120 pF | 270 pF | 330 pF | 560 pF | 1500 pF | 1800 pF | 5600 pF |
| 2000 | 68 pF | 120 pF | 270 pF | 470 pF | 1200 pF | 1500 pF | 4700 pF |
| 2500 | — | — | 100 pF | 220 pF | 560 pF | 820 pF | 2700 pF |
| 3000 | — | — | 82 pF | 180 pF | 270 pF | 680 pF | 2200 pF |
| 4000 | — | — | — | — | — | — | 1000 pF |
| 5000 | — | — | — | — | — | — | 680 pF |

X7R Dielectric

PERFORMANCE CHARACTERISTICS

| | |
|--|---|
| Capacitance Range | 1000 pF to 0.56 μ F (25°C, 1.0 \pm 0.2 Vrms at 1kHz) |
| Capacitance Tolerances | \pm 10%, \pm 20%, +80% -20% |
| Dissipation Factor | 2.5% max. (+25°C, 1.0 \pm 0.2 Vrms, 1kHz) |
| Operating Temperature Range | -55°C to +125°C |
| Temperature Characteristic | \pm 15% (0 VDC) |
| Voltage Ratings | 500, 600, 1000, 1500, 2000, 2500, 3000 & 4000 VDC (+125°C) |
| Insulation Resistance (+25°C, at 500 VDC) | 100,000 megohms min. or 1000 M Ω - μ F min., whichever is less |
| Insulation Resistance (+125°C, at 500 VDC) | 10,000 megohms min. or 100 M Ω - μ F min., whichever is less |
| Dielectric Strength | 120% rated voltage for 5 seconds at 50 mamp max. current |
| Thickness | Dependent upon size, voltage, and capacitance value |

X7R MAXIMUM CAPACITANCE VALUES

| VOLTAGE | 1206 | 1210 | 1808 | 1812 | 1825 | 2225 | 3640 |
|---------|--------------|--------------|--------------|--------------|--------------|--------------|--------------|
| 500 | .015 μ F | .027 μ F | — | .056 μ F | — | — | — |
| 600 | .015 μ F | .027 μ F | .039 μ F | .068 μ F | .15 μ F | .22 μ F | .56 μ F |
| 1000 | 4700 pF | 8200 pF | .015 μ F | .027 μ F | .068 μ F | .082 μ F | .22 μ F |
| 1500 | 1200 pF | 2700 pF | 2700 pF | 5600 pF | .012 μ F | .018 μ F | .056 μ F |
| 2000 | 470 pF | 820 pF | 1500 pF | 3300 pF | 6800 pF | .010 μ F | .027 μ F |
| 2500 | — | — | 1200 pF | 2200 pF | 5600 pF | 8200 pF | .022 μ F |
| 3000 | — | — | — | — | — | 4700 pF | .018 μ F |
| 4000 | — | — | — | — | — | — | 5600 pF |



General Specifications



Environmental

THERMAL SHOCK

Specification

Appearance

No visual defects

Capacitance Variation

COG (NP0): $\pm 2.5\%$ or $\pm .25\text{pF}$, whichever is greater
 X7R: $\leq \pm 7.5\%$
 Z5U: $\leq \pm 20\%$
 Y5V: $\leq \pm 20\%$

Q, Tan Delta

To meet initial requirement

Insulation Resistance

COG (NP0), X7R: To meet initial requirement
 Z5U, Y5V: $\geq \text{Initial Value} \times 0.1$

Dielectric Strength

No problem observed

Measuring Conditions

| Step | Temperature °C | Time (minutes) |
|------|--|----------------|
| 1 | COG (NP0), X7R: $-55^\circ \pm 2^\circ$ | 30 \pm 3 |
| | Z5U: $+10^\circ \pm 2^\circ$ | |
| | Y5V: $-30^\circ \pm 2^\circ$ | |
| 2 | Room Temperature | # 3 |
| 3 | COG (NP0), X7R: $+125^\circ \pm 2^\circ$ | 30 \pm 3 |
| | Z5U, Y5V: $+85^\circ \pm 2^\circ$ | |
| 4 | Room Temperature | # 3 |

Repeat for 5 cycles and measure after 48 hours \pm 4 hours (24 hours for COG (NP0)) at room temperature.

IMMERSION

Specification

Appearance

No visual defects

Capacitance Variation

COG (NP0): $\pm 2.5\%$ or $\pm .25\text{pF}$, whichever is greater
 X7R: $\leq \pm 7.5\%$
 Z5U: $\leq \pm 20\%$
 Y5V: $\leq \pm 20\%$

Q, Tan Delta

To meet initial requirement

Insulation Resistance

COG (NP0), X7R: To meet initial requirement
 Z5U, Y5V: $\geq \text{Initial Value} \times 0.1$

Dielectric Strength

No problem observed

Measuring Conditions

| Step | Temperature °C | Time (minutes) |
|------|------------------|----------------|
| 1 | +65 ± 5 / -0 | 15 \pm 2 |
| | Pure Water | |
| 2 | 0 \pm 3 | 15 \pm 2 |
| | NaCl solution | |

Repeat cycle 2 times and wash with water and dry.
 Store at room temperature for 48 \pm 4 hours (24 hours for COG (NP0)) and measure.

MOISTURE RESISTANCE

Specification

Appearance

No visual defects

Capacitance Variation

COG (NP0): $\pm 5\%$ or $\pm .5\text{pF}$, whichever is greater
 X7R: $\leq \pm 10\%$
 Z5U: $\leq \pm 30\%$
 Y5V: $\leq \pm 30\%$

Q, Tan Delta

COG (NP0): $\geq 30\text{pF}$ Q ≥ 350
 $\geq 10\text{pF}$, $< 30\text{pF}$ Q $\geq 275+5C/2$
 $< 10\text{pF}$ Q $\geq 200+10C$
 X7R: Initial requirement + .5%
 Z5U: Initial requirement + 1%
 Y5V: Initial requirement + 2%

Insulation Resistance

$\geq \text{Initial Value} \times 0.3$

Measuring Conditions

| Step | Temp. °C | Humidity % | Time (hrs) |
|------|-----------------------|--------------|------------|
| 1 | +25 \rightarrow +65 | 90-98 | 2.5 |
| 2 | +65 | 90-98 | 3.0 |
| 3 | +65 \rightarrow +25 | 80-98 | 2.5 |
| 4 | +25 \rightarrow +65 | 90-98 | 2.5 |
| 5 | +65 | 90-98 | 3.0 |
| 6 | +65 \rightarrow +25 | 80-98 | 2.5 |
| 7 | +25 | 90-98 | 2.0 |
| 7a | -10 | uncontrolled | - |
| 7b | +25 | 90-98 | - |

Repeat 20 cycles (1-7) and store for 48 hours (24 hours for COG (NP0)) at room temperature before measuring.
 Steps 7a & 7b are done on any 5 out of first 9 cycles.



Environmental

STEADY STATE HUMIDITY

(No Load)

Specification

Appearance

No visual defects

Capacitance Variation

C0G (NP0): $\pm 5\%$ or $\pm .5\text{pF}$, whichever is greater
X7R: $\leq \pm 10\%$
Z5U: $\leq \pm 30\%$
Y5V: $\leq \pm 30\%$

Q, Tan Delta

C0G (NP0): $\geq 30\text{pF}$ Q ≥ 350
 $\geq 10\text{pF}$, $< 30\text{pF}$ Q $\geq 275+5C/2$
 $< 10\text{pF}$ Q $\geq 200+10C$
X7R: Initial requirement + .5%
Z5U: Initial requirement + 1%
Y5V: Initial requirement + 2%

Insulation Resistance

\geq Initial Value x 0.3

Measuring Conditions

Store at $85 \pm 5\%$ relative humidity and 85°C for 1000 hours, without voltage. Remove from test chamber and stabilize at room temperature and humidity for 48 ± 4 hours (24 ± 2 hours for C0G (NP0)) before measuring.

Charge and discharge currents must be less than 50ma.

LOAD HUMIDITY

Specification

Appearance

No visual defects

Capacitance Variation

C0G (NP0): $\pm 5\%$ or $\pm .5\text{pF}$, whichever is greater
X7R: $\leq \pm 10\%$
Z5U: $\leq \pm 30\%$
Y5V: $\leq \pm 30\%$

Q, Tan Delta

C0G (NP0): $\geq 30\text{pF}$ Q ≥ 350
 $\geq 10\text{pF}$, $< 30\text{pF}$ Q $\geq 275+5C/2$
 $< 10\text{pF}$ Q $\geq 200+10C$
X7R: Initial requirement + .5%
Z5U: Initial requirement + 1%
Y5V: Initial requirement + 2%

Insulation Resistance

C0G (NP0), X7R: To meet initial value x 0.3
Z5U, Y5V: \geq Initial Value x 0.1

Charge devices with rated voltage in test chamber set at $85 \pm 5\%$ relative humidity and 85°C for 1000 (+48,-0) hours. Remove from test chamber and stabilize at room temperature and humidity for 48 ± 4 hours (24 ± 2 hours for C0G (NP0)) before measuring.

Charge and discharge currents must be less than 50ma.

LOAD LIFE

Specification

Appearance

No visual defects

Capacitance Variation

C0G (NP0): $\pm 3\%$ or $\pm .3\text{pF}$, whichever is greater
X7R: $\leq \pm 10\%$
Z5U: $\leq \pm 30\%$
Y5V: $\leq \pm 30\%$

Q, Tan Delta

C0G (NP0): $\geq 30\text{pF}$ Q ≥ 350
 $\geq 10\text{pF}$, $< 30\text{pF}$ Q $\geq 275+5C/2$
 $< 10\text{pF}$ Q $\geq 200+10C$
X7R: Initial requirement + .5%
Z5U: Initial requirement + 1%
Y5V: Initial requirement + 2%

Insulation Resistance

C0G (NP0), X7R: To meet initial value x 0.3
Z5U, Y5V: \geq Initial Value x 0.1

Charge devices with twice rated voltage in test chamber set at $+125^\circ\text{C} \pm 2^\circ\text{C}$ for C0G (NP0) and X7R, $+85^\circ \pm 2^\circ\text{C}$ for Z5U, and Y5V for 1000 (+48,-0) hours. Remove from test chamber and stabilize at room temperature for 48 ± 4 hours (24 ± 2 hours for C0G (NP0)) before measuring.

Charge and discharge currents must be less than 50ma.

Mechanical

END TERMINATION ADHERENCE

Specification

No evidence of peeling of end terminal

Measuring Conditions

After soldering devices to circuit board apply 5N (0.51kg f) for 10 ± 1 seconds, please refer to Figure 1.



Figure 1.
Terminal Adhesion

RESISTANCE TO VIBRATION

Specification

Appearance:

No visual defects

Capacitance

Within specified tolerance

Q, Tan Delta

To meet initial requirement

Insulation Resistance

COG (NP0), X7R \geq Initial Value x 0.3
Z5U, Y5V \geq Initial Value x 0.1

Measuring Conditions

Vibration Frequency

10-2000 Hz

Maximum Acceleration

20G

Swing Width

1.5mm

Test Time

X, Y, Z axis for 2 hours each, total 6 hours of test

SOLDERABILITY

Specification

$\geq 95\%$ of each termination end should be covered with fresh solder

Measuring Conditions

Dip device in eutectic solder at $230 \pm 5^\circ\text{C}$ for $2 \pm .5$ seconds

BEND STRENGTH

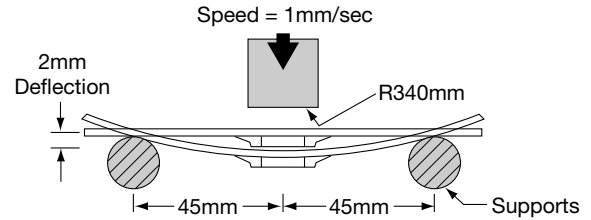

Figure 2. Bend Strength

Specification

Appearance:

No visual defects

Capacitance Variation

COG (NP0): $\pm 5\%$ or $\pm .5\text{pF}$, whichever is larger

X7R: $\leq \pm 12\%$

Z5U: $\leq \pm 30\%$

Y5V: $\leq \pm 30\%$

Insulation Resistance

COG (NP0): \geq Initial Value x 0.3

X7R: \geq Initial Value x 0.3

Z5U: \geq Initial Value x 0.1

Y5V: \geq Initial Value x 0.1

Measuring Conditions

Please refer to Figure 2

Deflection:

2mm

Test Time:

30 seconds

RESISTANCE TO SOLDER HEAT

Specification

Appearance:

No serious defects, $<25\%$ leaching of either end terminal

Capacitance Variation

COG (NP0): $\pm 2.5\%$ or $\pm 2.5\text{pF}$, whichever is greater

X7R: $\leq \pm 7.5\%$

Z5U: $\leq \pm 20\%$

Y5V: $\leq \pm 20\%$

Q, Tan Delta

To meet initial requirement

Insulation Resistance

To meet initial requirement

Dielectric Strength

No problem observed

Measuring Conditions

Dip device in eutectic solder at 260°C , for 1 minute. Store at room temperature for 48 hours (24 hours for COG (NP0)) before measuring electrical parameters.

Part sizes larger than $3.20\text{mm} \times 2.49\text{mm}$ are reheated at 150°C for 30 ± 5 seconds before performing test.

MIL-PRF-55681/Chips



Part Number Example

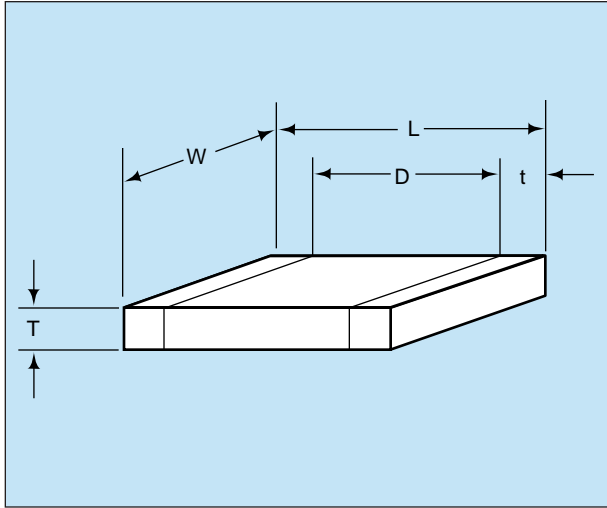

MILITARY DESIGNATION PER MIL-PRF-55681

Part Number Example

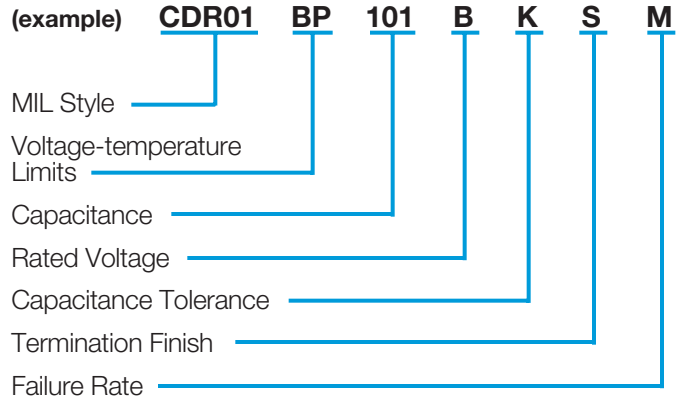

MIL Style: CDR01, CDR02, CDR03, CDR04, CDR05, CDR06

Voltage Temperature Limits:

BP = 0 ± 30 ppm/°C without voltage; 0 ± 30 ppm/°C with rated voltage from -55°C to +125°C

BX = $\pm 15\%$ without voltage; +15 -25% with rated voltage from -55°C to +125°C

Capacitance: Two digit figures followed by multiplier (number of zeros to be added) e.g., 101 = 100 pF

Rated Voltage: A = 50V, B = 100V

Capacitance Tolerance: J $\pm 5\%$, K $\pm 10\%$, M $\pm 20\%$

Termination Finish:

M = Palladium Silver
 N = Silver Nickel Gold
 S = Solder-coated

U = Base Metallization/Barrier Metal/Solder Coated*
 W = Base Metallization/Barrier Metal/Tinned (Tin or Tin/Lead Alloy)

*Solder shall have a melting point of 200°C or less.

Failure Rate Level: M = 1.0%, P = .1%, R = .01%, S = .001%

Packaging: Bulk is standard packaging. Tape and reel per RS481 is available upon request.

CROSS REFERENCE: AVX/MIL-PRF-55681/CDR01 THRU CDR06*

| Per MIL-PRF-55681 | AVX Style | Length (L) | Width (W) | Thickness (T) | | D | | Termination Band (t) | |
|-------------------|-----------|--|--|---------------|------|------|------|----------------------|------|
| | | | | Max. | Min. | Max. | Min. | Max. | Min. |
| CDR01 | 0805 | .080 ± .015 | .050 ± .015 | .055 | .020 | — | .030 | — | .010 |
| CDR02 | 1805 | .180 ± .015 | .050 ± .015 | .055 | .020 | — | — | .030 | .010 |
| CDR03 | 1808 | .180 ± .015 | .080 ± .018 | .080 | .020 | — | — | .030 | .010 |
| CDR04 | 1812 | .180 ± .015 | .125 ± .015 | .080 | .020 | — | — | .030 | .010 |
| CDR05 | 1825 | .180 ^{+.020} _{-.015} | .250 ^{+.020} _{-.015} | .080 | .020 | — | — | .030 | .010 |
| CDR06 | 2225 | .225 ± .020 | .250 ± .020 | .080 | .020 | — | — | .030 | .010 |

*For CDR11, 12, 13, and 14 see AVX Microwave Chip Capacitor Catalog

MIL-PRF-55681/Chips

Military Part Number Identification

CDR01 thru CDR06



CDR01 thru CDR06 to MIL-PRF-55681

| Military Type Designation | Capacitance in pF | Capacitance tolerance | Rated temperature and voltage-temperature limits | WVDC |
|-----------------------------|-------------------|-----------------------|--|------|
| AVX Style 0805/CDR01 | | | | |
| CDR01BP100B--- | 10 | J,K | BP | 100 |
| CDR01BP120B--- | 12 | J | BP | 100 |
| CDR01BP150B--- | 15 | J,K | BP | 100 |
| CDR01BP180B--- | 18 | J | BP | 100 |
| CDR01BP220B--- | 22 | J,K | BP | 100 |
| CDR01BP270B--- | 27 | J | BP | 100 |
| CDR01BP330B--- | 33 | J,K | BP | 100 |
| CDR01BP390B--- | 39 | J | BP | 100 |
| CDR01BP470B--- | 47 | J,K | BP | 100 |
| CDR01BP560B--- | 56 | J | BP | 100 |
| CDR01BP680B--- | 68 | J,K | BP | 100 |
| CDR01BP820B--- | 82 | J | BP | 100 |
| CDR01BP101B--- | 100 | J,K | BP | 100 |
| CDR01B--121B--- | 120 | J,K | BP,BX | 100 |
| CDR01B--151B--- | 150 | J,K | BP,BX | 100 |
| CDR01B--181B--- | 180 | J,K | BP,BX | 100 |
| CDR01BX221B--- | 220 | K,M | BX | 100 |
| CDR01BX271B--- | 270 | K | BX | 100 |
| CDR01BX331B--- | 330 | K,M | BX | 100 |
| CDR01BX391B--- | 390 | K | BX | 100 |
| CDR01BX471B--- | 470 | K,M | BX | 100 |
| CDR01BX561B--- | 560 | K | BX | 100 |
| CDR01BX681B--- | 680 | K,M | BX | 100 |
| CDR01BX821B--- | 820 | K | BX | 100 |
| CDR01BX102B--- | 1000 | K,M | BX | 100 |
| CDR01BX122B--- | 1200 | K | BX | 100 |
| CDR01BX152B--- | 1500 | K,M | BX | 100 |
| CDR01BX182B--- | 1800 | K | BX | 100 |
| CDR01BX222B--- | 2200 | K,M | BX | 100 |
| CDR01BX272B--- | 2700 | K | BX | 100 |
| CDR01BX332B--- | 3300 | K,M | BX | 100 |
| CDR01BX392A--- | 3900 | K | BX | 50 |
| CDR01BX472A--- | 4700 | K,M | BX | 50 |
| AVX Style 1805/CDR02 | | | | |
| CDR02BP221B--- | 220 | J,K | BP | 100 |
| CDR02BP271B--- | 270 | J | BP | 100 |
| CDR02BX392B--- | 3900 | K | BX | 100 |
| CDR02BX472B--- | 4700 | K,M | BX | 100 |
| CDR02BX562B--- | 5600 | K | BX | 100 |
| CDR02BX682B--- | 6800 | K,M | BX | 100 |
| CDR02BX822B--- | 8200 | K | BX | 100 |
| CDR02BX103B--- | 10,000 | K,M | BX | 100 |
| CDR02BX123A--- | 12,000 | K | BX | 50 |
| CDR02BX153A--- | 15,000 | K,M | BX | 50 |
| CDR02BX183A--- | 18,000 | K | BX | 50 |
| CDR02BX223A--- | 22,000 | K,M | BX | 50 |

- Add appropriate failure rate
- Add appropriate termination finish
- Capacitance Tolerance

| Military Type Designation | Capacitance in pF | Capacitance tolerance | Rated temperature and voltage-temperature limits | WVDC |
|-----------------------------|-------------------|-----------------------|--|------|
| AVX Style 1808/CDR03 | | | | |
| CDR03BP331B--- | 330 | J,K | BP | 100 |
| CDR03BP391B--- | 390 | J | BP | 100 |
| CDR03BP471B--- | 470 | J,K | BP | 100 |
| CDR03BP561B--- | 560 | J | BP | 100 |
| CDR03BP681B--- | 680 | J,K | BP | 100 |
| CDR03BP821B--- | 820 | J | BP | 100 |
| CDR03BP102B--- | 1000 | J,K | BP | 100 |
| CDR03BX123B--- | 12,000 | K | BX | 100 |
| CDR03BX153B--- | 15,000 | K,M | BX | 100 |
| CDR03BX183B--- | 18,000 | K | BX | 100 |
| CDR03BX223B--- | 22,000 | K,M | BX | 100 |
| CDR03BX273B--- | 27,000 | K | BX | 100 |
| CDR03BX333B--- | 33,000 | K,M | BX | 100 |
| CDR03BX393A--- | 39,000 | K | BX | 50 |
| CDR03BX473A--- | 47,000 | K,M | BX | 50 |
| CDR03BX563A--- | 56,000 | K | BX | 50 |
| CDR03BX683A--- | 68,000 | K,M | BX | 50 |
| AVX Style 1812/CDR04 | | | | |
| CDR04BP122B--- | 1200 | J | BP | 100 |
| CDR04BP152B--- | 1500 | J,K | BP | 100 |
| CDR04BP182B--- | 1800 | J | BP | 100 |
| CDR04BP222B--- | 2200 | J,K | BP | 100 |
| CDR04BP272B--- | 2700 | J | BP | 100 |
| CDR04BP332B--- | 3300 | J,K | BP | 100 |
| CDR04BX393B--- | 39,000 | K | BX | 100 |
| CDR04BX473B--- | 47,000 | K,M | BX | 100 |
| CDR04BX563B--- | 56,000 | K | BX | 100 |
| CDR04BX823A--- | 82,000 | K | BX | 50 |
| CDR04BX104A--- | 100,000 | K,M | BX | 50 |
| CDR04BX124A--- | 120,000 | K | BX | 50 |
| CDR04BX154A--- | 150,000 | K,M | BX | 50 |
| CDR04BX184A--- | 180,000 | K | BX | 50 |
| AVX Style 1825/CDR05 | | | | |
| CDR05BP392B--- | 3900 | J,K | BP | 100 |
| CDR05BP472B--- | 4700 | J,K | BP | 100 |
| CDR05BP562B--- | 5600 | J,K | BP | 100 |
| CDR05BX683B--- | 68,000 | K,M | BX | 100 |
| CDR05BX823B--- | 82,000 | K | BX | 100 |
| CDR05BX104B--- | 100,000 | K,M | BX | 100 |
| CDR05BX124B--- | 120,000 | K | BX | 100 |
| CDR05BX154B--- | 150,000 | K,M | BX | 100 |
| CDR05BX224A--- | 220,000 | K,M | BX | 50 |
| CDR05BX274A--- | 270,000 | K | BX | 50 |
| CDR05BX334A--- | 330,000 | K,M | BX | 50 |
| AVX Style 2225/CDR06 | | | | |
| CDR06BP682B--- | 6800 | J,K | BP | 100 |
| CDR06BP822B--- | 8200 | J,K | BP | 100 |
| CDR06BP103B--- | 10,000 | J,K | BP | 100 |
| CDR06BX394A--- | 390,000 | K | BX | 50 |
| CDR06BX474A--- | 470,000 | K,M | BX | 50 |

- Add appropriate failure rate
- Add appropriate termination finish
- Capacitance Tolerance



MIL-PRF-55681/Chips

Military Part Number Identification

CDR31 thru CDR35

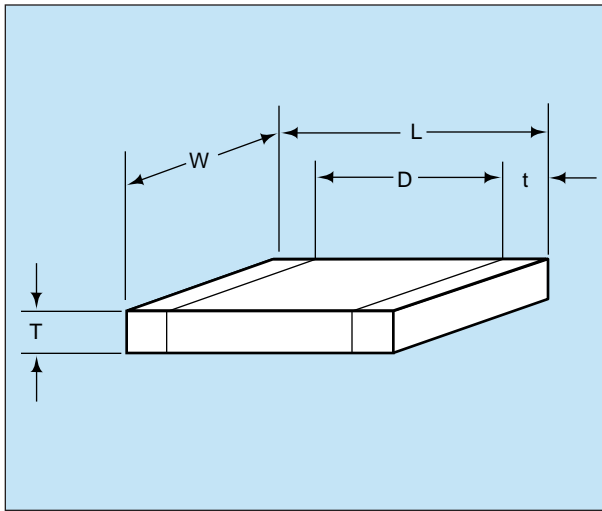

MILITARY DESIGNATION PER MIL-PRF-55681

Part Number Example

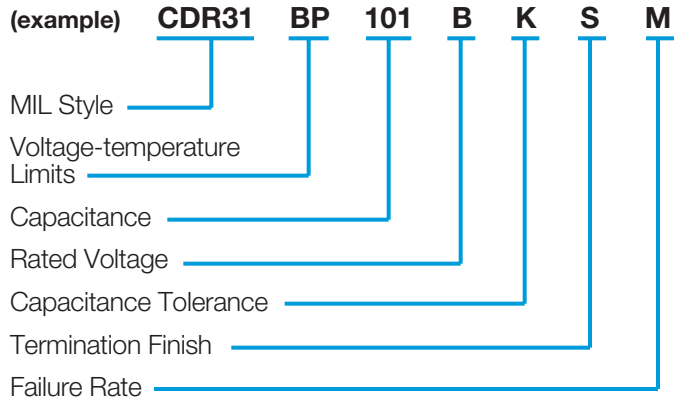

MIL Style: CDR31, CDR32, CDR33, CDR34, CDR35

Voltage Temperature Limits:

BP = 0 ± 30 ppm/ $^{\circ}\text{C}$ without voltage; 0 ± 30 ppm/ $^{\circ}\text{C}$ with rated voltage from -55°C to $+125^{\circ}\text{C}$

BX = $\pm 15\%$ without voltage; $+15 - 25\%$ with rated voltage from -55°C to $+125^{\circ}\text{C}$

Capacitance: Two digit figures followed by multiplier (number of zeros to be added) e.g., 101 = 100 pF

Rated Voltage: A = 50V, B = 100V

Capacitance Tolerance: C $\pm 25\%$ pF, D $\pm 5\%$ pF, F $\pm 1\%$
J $\pm 5\%$, K $\pm 10\%$, M $\pm 20\%$

Termination Finish:

M = Palladium Silver
N = Silver Nickel Gold
S = Solder-coated

U = Base Metallization/Barrier Metal/Solder Coated*
W = Base Metallization/Barrier Metal/Tinned (Tin or Tin/Lead Alloy)

*Solder shall have a melting point of 200°C or less.

Failure Rate Level: M = 1.0%, P = .1%, R = .01%, S = .001%

Packaging: Bulk is standard packaging. Tape and reel per RS481 is available upon request.

CROSS REFERENCE: AVX/MIL-PRF-55681/CDR31 THRU CDR35

| Per MIL-PRF-55681 (Metric Sizes) | AVX Style | Length (L) (mm) | Width (W) (mm) | Thickness (T) | D | Termination Band (t) | |
|----------------------------------|-----------|-----------------|----------------|---------------|-----------|----------------------|-----------|
| | | | | Max. (mm) | Min. (mm) | Max. (mm) | Min. (mm) |
| CDR31 | 0805 | 2.00 | 1.25 | 1.3 | .50 | .70 | .30 |
| CDR32 | 1206 | 3.20 | 1.60 | 1.3 | — | .70 | .30 |
| CDR33 | 1210 | 3.20 | 2.50 | 1.5 | — | .70 | .30 |
| CDR34 | 1812 | 4.50 | 3.20 | 1.5 | — | .70 | .30 |
| CDR35 | 1825 | 4.50 | 6.40 | 1.5 | — | .70 | .30 |

MIL-PRF-55681/Chips



Military Part Number Identification CDR31

CDR31 to MIL-PRF-55681/7

| Military Type Designation 1/ | Capacitance in pF | Capacitance tolerance | Rated temperature and voltage-temperature limits | WVDC |
|----------------------------------|-------------------|-----------------------|--|------|
| AVX Style 0805/CDR31 (BP) | | | | |
| CDR31BP1R0B--- | 1.0 | C | BP | 100 |
| CDR31BP1R1B--- | 1.1 | C | BP | 100 |
| CDR31BP1R2B--- | 1.2 | C | BP | 100 |
| CDR31BP1R3B--- | 1.3 | C | BP | 100 |
| CDR31BP1R5B--- | 1.5 | C | BP | 100 |
| CDR31BP1R6B--- | 1.6 | C | BP | 100 |
| CDR31BP1R8B--- | 1.8 | C | BP | 100 |
| CDR31BP2R0B--- | 2.0 | C | BP | 100 |
| CDR31BP2R2B--- | 2.2 | C | BP | 100 |
| CDR31BP2R4B--- | 2.4 | C | BP | 100 |
| CDR31BP2R7B--- | 2.7 | C,D | BP | 100 |
| CDR31BP3R0B--- | 3.0 | C,D | BP | 100 |
| CDR31BP3R3B--- | 3.3 | C,D | BP | 100 |
| CDR31BP3R6B--- | 3.6 | C,D | BP | 100 |
| CDR31BP3R9B--- | 3.9 | C,D | BP | 100 |
| CDR31BP4R3B--- | 4.3 | C,D | BP | 100 |
| CDR31BP4R7B--- | 4.7 | C,D | BP | 100 |
| CDR31BP5R1B--- | 5.1 | C,D | BP | 100 |
| CDR31BP5R6B--- | 5.6 | C,D | BP | 100 |
| CDR31BP6R2B--- | 6.2 | C,D | BP | 100 |
| CDR31BP6R8B--- | 6.8 | C,D | BP | 100 |
| CDR31BP7R5B--- | 7.5 | C,D | BP | 100 |
| CDR31BP8R2B--- | 8.2 | C,D | BP | 100 |
| CDR31BP9R1B--- | 9.1 | C,D | BP | 100 |
| CDR31BP100B--- | 10 | J,K | BP | 100 |
| CDR31BP110B--- | 11 | J,K | BP | 100 |
| CDR31BP120B--- | 12 | J,K | BP | 100 |
| CDR31BP130B--- | 13 | J,K | BP | 100 |
| CDR31BP150B--- | 15 | J,K | BP | 100 |
| CDR31BP160B--- | 16 | J,K | BP | 100 |
| CDR31BP180B--- | 18 | J,K | BP | 100 |
| CDR31BP200B--- | 20 | J,K | BP | 100 |
| CDR31BP220B--- | 22 | J,K | BP | 100 |
| CDR31BP240B--- | 24 | J,K | BP | 100 |
| CDR31BP270B--- | 27 | F,J,K | BP | 100 |
| CDR31BP300B--- | 30 | F,J,K | BP | 100 |
| CDR31BP330B--- | 33 | F,J,K | BP | 100 |
| CDR31BP360B--- | 36 | F,J,K | BP | 100 |
| CDR31BP390B--- | 39 | F,J,K | BP | 100 |
| CDR31BP430B--- | 43 | F,J,K | BP | 100 |
| CDR31BP470B--- | 47 | F,J,K | BP | 100 |
| CDR31BP510B--- | 51 | F,J,K | BP | 100 |
| CDR31BP560B--- | 56 | F,J,K | BP | 100 |
| CDR31BP620B--- | 62 | F,J,K | BP | 100 |
| CDR31BP680B--- | 68 | F,J,K | BP | 100 |
| CDR31BP750B--- | 75 | F,J,K | BP | 100 |
| CDR31BP820B--- | 82 | F,J,K | BP | 100 |
| CDR31BP910B--- | 91 | F,J,K | BP | 100 |

- Add appropriate failure rate
- Add appropriate termination finish
- Capacitance Tolerance

| Military Type Designation 1/ | Capacitance in pF | Capacitance tolerance | Rated temperature and voltage-temperature limits | WVDC |
|---|-------------------|-----------------------|--|------|
| AVX Style 0805/CDR31 (BP) cont'd | | | | |
| CDR31BP101B--- | 100 | F,J,K | BP | 100 |
| CDR31BP111B--- | 110 | F,J,K | BP | 100 |
| CDR31BP121B--- | 120 | F,J,K | BP | 100 |
| CDR31BP131B--- | 130 | F,J,K | BP | 100 |
| CDR31BP151B--- | 150 | F,J,K | BP | 100 |
| CDR31BP161B--- | 160 | F,J,K | BP | 100 |
| CDR31BP181B--- | 180 | F,J,K | BP | 100 |
| CDR31BP201B--- | 200 | F,J,K | BP | 100 |
| CDR31BP221B--- | 220 | F,J,K | BP | 100 |
| CDR31BP241B--- | 240 | F,J,K | BP | 100 |
| CDR31BP271B--- | 270 | F,J,K | BP | 100 |
| CDR31BP301B--- | 300 | F,J,K | BP | 100 |
| CDR31BP331B--- | 330 | F,J,K | BP | 100 |
| CDR31BP361B--- | 360 | F,J,K | BP | 100 |
| CDR31BP391B--- | 390 | F,J,K | BP | 100 |
| CDR31BP431B--- | 430 | F,J,K | BP | 100 |
| CDR31BP471B--- | 470 | F,J,K | BP | 100 |
| CDR31BP511A--- | 510 | F,J,K | BP | 50 |
| CDR31BP561A--- | 560 | F,J,K | BP | 50 |
| CDR31BP621A--- | 620 | F,J,K | BP | 50 |
| CDR31BP681A--- | 680 | F,J,K | BP | 50 |
| AVX Style 0805/CDR31 (BX) | | | | |
| CDR31BX471B--- | 470 | K,M | BX | 100 |
| CDR31BX561B--- | 560 | K,M | BX | 100 |
| CDR31BX681B--- | 680 | K,M | BX | 100 |
| CDR31BX821B--- | 820 | K,M | BX | 100 |
| CDR31BX102B--- | 1,000 | K,M | BX | 100 |
| CDR31BX122B--- | 1,200 | K,M | BX | 100 |
| CDR31BX152B--- | 1,500 | K,M | BX | 100 |
| CDR31BX182B--- | 1,800 | K,M | BX | 100 |
| CDR31BX222B--- | 2,200 | K,M | BX | 100 |
| CDR31BX272B--- | 2,700 | K,M | BX | 100 |
| CDR31BX332B--- | 3,300 | K,M | BX | 100 |
| CDR31BX392B--- | 3,900 | K,M | BX | 100 |
| CDR31BX472B--- | 4,700 | K,M | BX | 100 |
| CDR31BX562A--- | 5,600 | K,M | BX | 50 |
| CDR31BX682A--- | 6,800 | K,M | BX | 50 |
| CDR31BX822A--- | 8,200 | K,M | BX | 50 |
| CDR31BX103A--- | 10,000 | K,M | BX | 50 |
| CDR31BX123A--- | 12,000 | K,M | BX | 50 |
| CDR31BX153A--- | 15,000 | K,M | BX | 50 |
| CDR31BX183A--- | 18,000 | K,M | BX | 50 |

- Add appropriate failure rate
- Add appropriate termination finish
- Capacitance Tolerance

1/ The complete part number will include additional symbols to indicate capacitance tolerance, termination and failure rate level.



MIL-PRF-55681/Chips



Military Part Number Identification CDR32

CDR32 to MIL-PRF-55681/8

| Military Type Designation 1/ | Capacitance in pF | Capacitance tolerance | Rated temperature and voltage-temperature limits | WVDC |
|----------------------------------|-------------------|-----------------------|--|------|
| AVX Style 1206/CDR32 (BP) | | | | |
| CDR32BP1R0B--- | 1.0 | C | BP | 100 |
| CDR32BP1R1B--- | 1.1 | C | BP | 100 |
| CDR32BP1R2B--- | 1.2 | C | BP | 100 |
| CDR32BP1R3B--- | 1.3 | C | BP | 100 |
| CDR32BP1R5B--- | 1.5 | C | BP | 100 |
| CDR32BP1R6B--- | 1.6 | C | BP | 100 |
| CDR32BP1R8B--- | 1.8 | C | BP | 100 |
| CDR32BP2R0B--- | 2.0 | C | BP | 100 |
| CDR32BP2R2B--- | 2.2 | C | BP | 100 |
| CDR32BP2R4B--- | 2.4 | C | BP | 100 |
| CDR32BP2R7B--- | 2.7 | C,D | BP | 100 |
| CDR32BP3R0B--- | 3.0 | C,D | BP | 100 |
| CDR32BP3R3B--- | 3.3 | C,D | BP | 100 |
| CDR32BP3R6B--- | 3.6 | C,D | BP | 100 |
| CDR32BP3R9B--- | 3.9 | C,D | BP | 100 |
| CDR32BP4R3B--- | 4.3 | C,D | BP | 100 |
| CDR32BP4R7B--- | 4.7 | C,D | BP | 100 |
| CDR32BP5R1B--- | 5.1 | C,D | BP | 100 |
| CDR32BP5R6B--- | 5.6 | C,D | BP | 100 |
| CDR32BP6R2B--- | 6.2 | C,D | BP | 100 |
| CDR32BP6R8B--- | 6.8 | C,D | BP | 100 |
| CDR32BP7R5B--- | 7.5 | C,D | BP | 100 |
| CDR32BP8R2B--- | 8.2 | C,D | BP | 100 |
| CDR32BP9R1B--- | 9.1 | C,D | BP | 100 |
| CDR32BP100B--- | 10 | J,K | BP | 100 |
| CDR32BP110B--- | 11 | J,K | BP | 100 |
| CDR32BP120B--- | 12 | J,K | BP | 100 |
| CDR32BP130B--- | 13 | J,K | BP | 100 |
| CDR32BP150B--- | 15 | J,K | BP | 100 |
| CDR32BP160B--- | 16 | J,K | BP | 100 |
| CDR32BP180B--- | 18 | J,K | BP | 100 |
| CDR32BP200B--- | 20 | J,K | BP | 100 |
| CDR32BP220B--- | 22 | J,K | BP | 100 |
| CDR32BP240B--- | 24 | J,K | BP | 100 |
| CDR32BP270B--- | 27 | F,J,K | BP | 100 |
| CDR32BP300B--- | 30 | F,J,K | BP | 100 |
| CDR32BP330B--- | 33 | F,J,K | BP | 100 |
| CDR32BP360B--- | 36 | F,J,K | BP | 100 |
| CDR32BP390B--- | 39 | F,J,K | BP | 100 |
| CDR32BP430B--- | 43 | F,J,K | BP | 100 |
| CDR32BP470B--- | 47 | F,J,K | BP | 100 |
| CDR32BP510B--- | 51 | F,J,K | BP | 100 |
| CDR32BP560B--- | 56 | F,J,K | BP | 100 |
| CDR32BP620B--- | 62 | F,J,K | BP | 100 |
| CDR32BP680B--- | 68 | F,J,K | BP | 100 |
| CDR32BP750B--- | 75 | F,J,K | BP | 100 |
| CDR32BP820B--- | 82 | F,J,K | BP | 100 |
| CDR32BP910B--- | 91 | F,J,K | BP | 100 |

- Add appropriate failure rate
- Add appropriate termination finish
- Capacitance Tolerance

| Military Type Designation 1/ | Capacitance in pF | Capacitance tolerance | Rated temperature and voltage-temperature limits | WVDC |
|---|-------------------|-----------------------|--|------|
| AVX Style 1206/CDR32 (BP) cont'd | | | | |
| CDR32BP101B--- | 100 | F,J,K | BP | 100 |
| CDR32BP111B--- | 110 | F,J,K | BP | 100 |
| CDR32BP121B--- | 120 | F,J,K | BP | 100 |
| CDR32BP131B--- | 130 | F,J,K | BP | 100 |
| CDR32BP151B--- | 150 | F,J,K | BP | 100 |
| CDR32BP161B--- | 160 | F,J,K | BP | 100 |
| CDR32BP181B--- | 180 | F,J,K | BP | 100 |
| CDR32BP201B--- | 200 | F,J,K | BP | 100 |
| CDR32BP221B--- | 220 | F,J,K | BP | 100 |
| CDR32BP241B--- | 240 | F,J,K | BP | 100 |
| CDR32BP271B--- | 270 | F,J,K | BP | 100 |
| CDR32BP301B--- | 300 | F,J,K | BP | 100 |
| CDR32BP331B--- | 330 | F,J,K | BP | 100 |
| CDR32BP361B--- | 360 | F,J,K | BP | 100 |
| CDR32BP391B--- | 390 | F,J,K | BP | 100 |
| CDR32BP431B--- | 430 | F,J,K | BP | 100 |
| CDR32BP471B--- | 470 | F,J,K | BP | 100 |
| CDR32BP511B--- | 510 | F,J,K | BP | 100 |
| CDR32BP561B--- | 560 | F,J,K | BP | 100 |
| CDR32BP621B--- | 620 | F,J,K | BP | 100 |
| CDR32BP681B--- | 680 | F,J,K | BP | 100 |
| CDR32BP751B--- | 750 | F,J,K | BP | 100 |
| CDR32BP821B--- | 820 | F,J,K | BP | 100 |
| CDR32BP911B--- | 910 | F,J,K | BP | 100 |
| CDR32BP102B--- | 1,000 | F,J,K | BP | 100 |
| CDR32BP112A--- | 1,100 | F,J,K | BP | 50 |
| CDR32BP122A--- | 1,200 | F,J,K | BP | 50 |
| CDR32BP132A--- | 1,300 | F,J,K | BP | 50 |
| CDR32BP152A--- | 1,500 | F,J,K | BP | 50 |
| CDR32BP162A--- | 1,600 | F,J,K | BP | 50 |
| CDR32BP182A--- | 1,800 | F,J,K | BP | 50 |
| CDR32BP202A--- | 2,000 | F,J,K | BP | 50 |
| CDR32BP222A--- | 2,200 | F,J,K | BP | 50 |
| AVX Style 1206/CDR32 (BX) | | | | |
| CDR32BX472B--- | 4,700 | K,M | BX | 100 |
| CDR32BX562B--- | 5,600 | K,M | BX | 100 |
| CDR32BX682B--- | 6,800 | K,M | BX | 100 |
| CDR32BX822B--- | 8,200 | K,M | BX | 100 |
| CDR32BX103B--- | 10,000 | K,M | BX | 100 |
| CDR32BX123B--- | 12,000 | K,M | BX | 100 |
| CDR32BX153B--- | 15,000 | K,M | BX | 100 |
| CDR32BX183A--- | 18,000 | K,M | BX | 50 |
| CDR32BX223A--- | 22,000 | K,M | BX | 50 |
| CDR32BX273A--- | 27,000 | K,M | BX | 50 |
| CDR32BX333A--- | 33,000 | K,M | BX | 50 |
| CDR32BX393A--- | 39,000 | K,M | BX | 50 |

- Add appropriate failure rate
- Add appropriate termination finish
- Capacitance Tolerance

1/ The complete part number will include additional symbols to indicate capacitance tolerance, termination and failure rate level.

CDR33/34/35 to MIL-PRF-55681/9/10/11

| Military Type Designation 1/ | Capacitance in pF | Capacitance tolerance | Rated temperature and voltage-temperature limits | WVDC |
|----------------------------------|-------------------|-----------------------|--|------|
| AVX Style 1210/CDR33 (BP) | | | | |
| CDR33BP102B--- | 1,000 | F,J,K | BP | 100 |
| CDR33BP112B--- | 1,100 | F,J,K | BP | 100 |
| CDR33BP122B--- | 1,200 | F,J,K | BP | 100 |
| CDR33BP132B--- | 1,300 | F,J,K | BP | 100 |
| CDR33BP152B--- | 1,500 | F,J,K | BP | 100 |
| CDR33BP162B--- | 1,600 | F,J,K | BP | 100 |
| CDR33BP182B--- | 1,800 | F,J,K | BP | 100 |
| CDR33BP202B--- | 2,000 | F,J,K | BP | 100 |
| CDR33BP222B--- | 2,200 | F,J,K | BP | 100 |
| CDR33BP242A--- | 2,400 | F,J,K | BP | 50 |
| CDR33BP272A--- | 2,700 | F,J,K | BP | 50 |
| CDR33BP302A--- | 3,000 | F,J,K | BP | 50 |
| CDR33BP332A--- | 3,300 | F,J,K | BP | 50 |
| AVX Style 1210/CDR33 (BX) | | | | |
| CDR33BX153B--- | 15,000 | K,M | BX | 100 |
| CDR33BX183B--- | 18,000 | K,M | BX | 100 |
| CDR33BX223B--- | 22,000 | K,M | BX | 100 |
| CDR33BX273B--- | 27,000 | K,M | BX | 100 |
| CDR33BX393A--- | 39,000 | K,M | BX | 50 |
| CDR33BX473A--- | 47,000 | K,M | BX | 50 |
| CDR33BX563A--- | 56,000 | K,M | BX | 50 |
| CDR33BX683A--- | 68,000 | K,M | BX | 50 |
| CDR33BX823A--- | 82,000 | K,M | BX | 50 |
| CDR33BX104A--- | 100,000 | K,M | BX | 50 |
| AVX Style 1812/CDR34 (BP) | | | | |
| CDR34BP222B--- | 2,200 | F,J,K | BP | 100 |
| CDR34BP242B--- | 2,400 | F,J,K | BP | 100 |
| CDR34BP272B--- | 2,700 | F,J,K | BP | 100 |
| CDR34BP302B--- | 3,000 | F,J,K | BP | 100 |
| CDR34BP332B--- | 3,300 | F,J,K | BP | 100 |
| CDR34BP362B--- | 3,600 | F,J,K | BP | 100 |
| CDR34BP392B--- | 3,900 | F,J,K | BP | 100 |
| CDR34BP432B--- | 4,300 | F,J,K | BP | 100 |
| CDR34BP472B--- | 4,700 | F,J,K | BP | 100 |
| CDR34BP512A--- | 5,100 | F,J,K | BP | 50 |
| CDR34BP562A--- | 5,600 | F,J,K | BP | 50 |
| CDR34BP622A--- | 6,200 | F,J,K | BP | 50 |
| CDR34BP682A--- | 6,800 | F,J,K | BP | 50 |
| CDR34BP752A--- | 7,500 | F,J,K | BP | 50 |
| CDR34BP822A--- | 8,200 | F,J,K | BP | 50 |
| CDR34BP912A--- | 9,100 | F,J,K | BP | 50 |
| CDR34BP103A--- | 10,000 | F,J,K | BP | 50 |

- Add appropriate failure rate
- Add appropriate termination finish
- Capacitance Tolerance

| Military Type Designation 1/ | Capacitance in pF | Capacitance tolerance | Rated temperature and voltage-temperature limits | WVDC |
|----------------------------------|-------------------|-----------------------|--|------|
| AVX Style 1812/CDR34 (BX) | | | | |
| CDR34BX273B--- | 27,000 | K,M | BX | 100 |
| CDR34BX333B--- | 33,000 | K,M | BX | 100 |
| CDR34BX393B--- | 39,000 | K,M | BX | 100 |
| CDR34BX473B--- | 47,000 | K,M | BX | 100 |
| CDR34BX563B--- | 56,000 | K,M | BX | 100 |
| CDR34BX104A--- | 100,000 | K,M | BX | 50 |
| CDR34BX124A--- | 120,000 | K,M | BX | 50 |
| CDR34BX154A--- | 150,000 | K,M | BX | 50 |
| CDR34BX184A--- | 180,000 | K,M | BX | 50 |
| AVX Style 1825/CDR35 (BP) | | | | |
| CDR35BP472B--- | 4,700 | F,J,K | BP | 100 |
| CDR35BP512B--- | 5,100 | F,J,K | BP | 100 |
| CDR35BP562B--- | 5,600 | F,J,K | BP | 100 |
| CDR35BP622B--- | 6,200 | F,J,K | BP | 100 |
| CDR35BP682B--- | 6,800 | F,J,K | BP | 100 |
| CDR35BP752B--- | 7,500 | F,J,K | BP | 100 |
| CDR35BP822B--- | 8,200 | F,J,K | BP | 100 |
| CDR35BP912B--- | 9,100 | F,J,K | BP | 100 |
| CDR35BP103B--- | 10,000 | F,J,K | BP | 100 |
| CDR35BP113A--- | 11,000 | F,J,K | BP | 50 |
| CDR35BP123A--- | 12,000 | F,J,K | BP | 50 |
| CDR35BP133A--- | 13,000 | F,J,K | BP | 50 |
| CDR35BP153A--- | 15,000 | F,J,K | BP | 50 |
| CDR35BP163A--- | 16,000 | F,J,K | BP | 50 |
| CDR35BP183A--- | 18,000 | F,J,K | BP | 50 |
| CDR35BP203A--- | 20,000 | F,J,K | BP | 50 |
| CDR35BP223A--- | 22,000 | F,J,K | BP | 50 |
| AVX Style 1825/CDR35 (BX) | | | | |
| CDR35BX563B--- | 56,000 | K,M | BX | 100 |
| CDR35BX683B--- | 68,000 | K,M | BX | 100 |
| CDR35BX823B--- | 82,000 | K,M | BX | 100 |
| CDR35BX104B--- | 100,000 | K,M | BX | 100 |
| CDR35BX124B--- | 120,000 | K,M | BX | 100 |
| CDR35BX154B--- | 150,000 | K,M | BX | 100 |
| CDR35BX184A--- | 180,000 | K,M | BX | 50 |
| CDR35BX224A--- | 220,000 | K,M | BX | 50 |
| CDR35BX274A--- | 270,000 | K,M | BX | 50 |
| CDR35BX334A--- | 330,000 | K,M | BX | 50 |
| CDR35BX394A--- | 390,000 | K,M | BX | 50 |
| CDR35BX474A--- | 470,000 | K,M | BX | 50 |

- Add appropriate failure rate
- Add appropriate termination finish
- Capacitance Tolerance

1/ The complete part number will include additional symbols to indicate capacitance tolerance, termination and failure rate level.

European Detail Specifications CECC 32 101-801/Chips



Standard European Ceramic Chip Capacitors

PART NUMBER (example)

0805



Size
(L" x W")

5



Voltage
50V = 5
100V = 1
200V = 2

C



Dielectric
1B CG = A
2R1 = C
2F4 = G

103



Capacitance Code

M



Capacitance Tolerance
See Dielectrics
COG, X7R, Y5V

T



Specification
CECC32101-801

T



Terminations
T = Plated Ni
and Sn

2



Marking Packaging
2 = 7" Reel
4 = 13" Reel

A



Special Code
A = Std.
Product

RANGE OF APPROVED COMPONENTS

| Case Size | Dielectric Type | Voltage and Capacitance Range | | |
|-------------|-----------------|-------------------------------|----------------|----------------|
| | | 50V | 100V | 200V |
| 1BCG | | | | |
| 0603 | 1B CG | 0.47pF - 150pF | 0.47pF - 120pF | 0.47pF - 100pF |
| 0805 | 1B CG | 0.47pF - 560pF | 0.47pF - 560pF | 0.47pF - 330pF |
| 1206 | 1B CG | 0.47pF - 3.3nF | 0.47pF - 3.3nF | 0.47pF - 1.5nF |
| 1210 | 1B CG | 0.47pF - 4.7nF | 0.47pF - 4.7nF | 0.47pF - 2.7nF |
| 1808 | 1B CG | 0.47pF - 6.8nF | 0.47pF - 6.8nF | 0.47pF - 4.7nF |
| 1812 | 1B CG | 0.47pF - 15nF | 0.47pF - 15nF | 0.47pF - 10nF |
| 2220 | 1B CG | 0.47pF - 39nF | 0.47pF - 39nF | 0.47pF - 15nF |
| 2R1 | | | | |
| 0603 | 2R1 | 10pF - 6.8nF | 10pF - 6.8nF | 10pF - 1.2nF |
| 0805 | 2R1 | 10pF - 33nF | 10pF - 18nF | 10pF - 3.3nF |
| 1206 | 2R1 | 10pF - 100nF | 10pF - 68nF | 10pF - 18nF |
| 1210 | 2R1 | 10pF - 150nF | 10pF - 100nF | 10pF - 27nF |
| 1808 | 2R1 | 10pF - 270nF | 10pF - 180nF | 10pF - 47nF |
| 1812 | 2R1 | 10pF - 470nF | 10pF - 330nF | 10pF - 100nF |
| 2220 | 2R1 | 10pF - 1.2μF | 10pF - 680nF | 10pF - 220nF |
| 2F4 | | | | |
| 0805 | 2F4 | 10pF - 100nF | | |
| 1206 | 2F4 | 10pF - 330nF | | |
| 1210 | 2F4 | 10pF - 470nF | | |
| 1808 | 2F4 | 10pF - 560nF | | |
| 1812 | 2F4 | 10pF - 1.8μF | | |
| 2220 | 2F4 | 10pF - 2.2μF | | |

Packaging of Chip Components



Automatic Insertion Packaging

TAPE & REEL QUANTITIES

All tape and reel specifications are in compliance with RS481.

| | 8mm | 12mm | |
|---------------------------|-------------------------------|------------------|------------------------|
| Paper or Embossed Carrier | 0805, 1005, 1206, 1210 | | |
| Embossed Only | 0504, 0907 | 1505, 1805, 1808 | 1812, 1825, 2220, 2225 |
| Paper Only | 0402, 0603 | | |
| Qty. per Reel/7" Reel | 2,000 or 4,000 ⁽¹⁾ | 3,000 | 1,000 |
| Qty. per Reel/13" Reel | 10,000 | 10,000 | 4,000 |

⁽¹⁾ Dependent on chip thickness. Low profile chips shown on page 27 are 5,000 per reel for 7" reel. 0402 size chips are 10,000 per 7" reels and are not available on 13" reels. For 3640 size chip contact factory for quantity per reel.

REEL DIMENSIONS

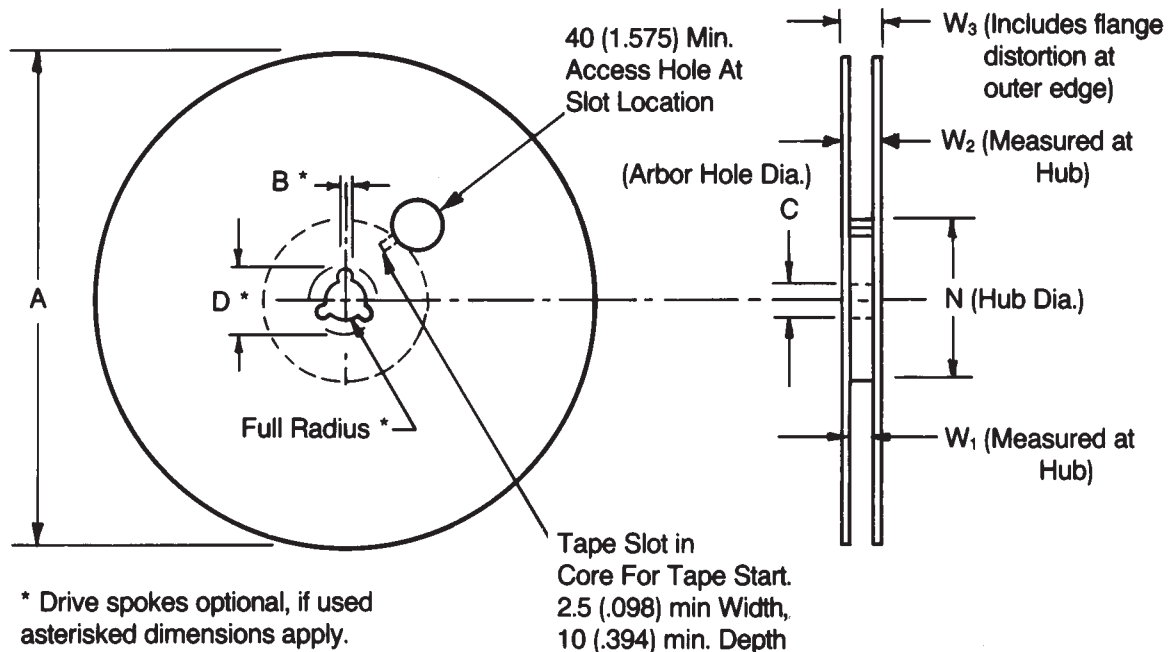

| Tape Size ⁽¹⁾ | A Max. | B* Min. | C | D* Min. | N Min. | W ₁ | W ₂ Max. | W ₃ |
|--------------------------|-----------------|---------------|--------------------------|----------------|---------------|--|---------------------|---------------------|
| 8mm | 330 (12.992) | 1.5 (.059) | 13.0±0.20 (.512±.008) | 20.2 (.795) | 50 (1.969) | 8.4 ^{+1.0} _{-0.0} (.331 ^{+0.60} _{-0.0}) | 14.4 (.567) | 7.9 Min. (.311) |
| 12mm | | | | | | 12.4 ^{+2.0} _{-0.0} (.488 ^{+0.76} _{-0.0}) | | 11.9 Min. (.469) |

Metric dimensions will govern.

English measurements rounded and for reference only.

⁽¹⁾ For tape sizes 16mm and 24mm (used with chip size 3640) consult EIA RS-481 latest revision.

Embossed Carrier Configuration



8 & 12mm Tape Only

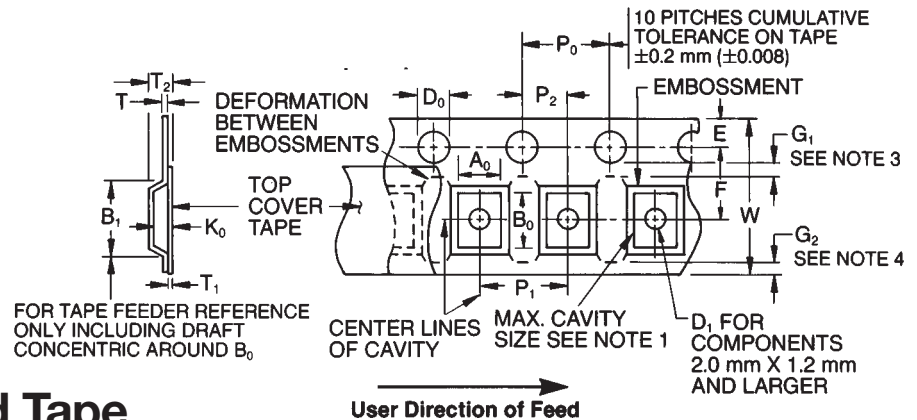

8 & 12mm Embossed Tape Metric Dimensions Will Govern

CONSTANT DIMENSIONS

| Tape Size | D ₀ | E | P ₀ | P ₂ | T Max. | T ₁ | G ₁ | G ₂ |
|--------------|---|------------------------------|-----------------------------|-----------------------------|-----------------|------------------------|--------------------------------------|--------------------------------------|
| 8mm and 12mm | 8.4 ^{+0.10} _{-0.0} (.059 ^{+0.004} _{-0.0}) | 1.75 ± 0.10 (.069 ± .004) | 4.0 ± 0.10 (.157 ± .004) | 2.0 ± 0.05 (.079 ± .002) | 0.600 (.024) | 0.10 (.004) Max. | 0.75 (.030) Min. See Note 3 | 0.75 (.030) Min. See Note 4 |

VARIABLE DIMENSIONS

| Tape Size | B ₁ Max. See Note 6 | D ₁ Min. See Note 5 | F | P ₁ | R Min. See Note 2 | T ₂ | W | A ₀ B ₀ K ₀ |
|----------------------|-----------------------------------|-----------------------------------|-----------------------------|-----------------------------|----------------------|--------------------|--|--|
| 8mm | 4.55 (.179) | 1.0 (.039) | 3.5 ± 0.05 (.138 ± .002) | 4.0 ± 0.10 (.157 ± .004) | 25 (.984) | 2.5 Max. (.098) | 8.0 ^{+0.3} _{-0.1} (.315 ^{+0.012} _{-0.004}) | See Note 1 |
| 12mm | 8.2 (.323) | 1.5 (.059) | 5.5 ± 0.05 (.217 ± .002) | 4.0 ± 0.10 (.157 ± .004) | 30 (1.181) | 6.5 Max. (.256) | 12.0 ± .30 (.472 ± .012) | See Note 1 |
| 8mm 1/2 Pitch | 4.55 (.179) | 1.0 (.039) | 3.5 ± 0.05 (.138 ± .002) | 2.0 ± 0.10 0.79 ± .004 | 25 (.984) | 2.5 Max. (.098) | 8.0 ^{+0.3} _{-0.1} (.315 ^{+0.012} _{-0.004}) | See Note 1 |
| 12mm Double Pitch | 8.2 (.323) | 1.5 (.059) | 5.5 ± 0.05 (.217 ± .002) | 8.0 ± 0.10 (.315 ± .004) | 30 (1.181) | 6.5 Max. (.256) | 12.0 ± .30 (.472 ± .012) | See Note 1 |

NOTES:

- A₀, B₀, and K₀ are determined by the max. dimensions to the ends of the terminals extending from the component body and/or the body dimensions of the component. The clearance between the end of the terminals or body of the component to the sides and depth of the cavity (A₀, B₀, and K₀) must be within 0.05 mm (.002) min. and 0.50 mm (.020) max. The clearance allowed must also prevent rotation of the component within the cavity of not more than 20 degrees (see sketches C & D).
- Tape with components shall pass around radius "R" without damage. The minimum trailer length (Note 2 Fig. 3) may require additional length to provide R min. for 12 mm embossed tape for reels with hub diameters approaching N min. (Table 4).
- G₁ dimension is the flat area from the edge of the sprocket hole to either the outward deformation of the carrier tape between the embossed cavities or to the edge of the cavity whichever is less.
- G₂ dimension is the flat area from the edge of the carrier tape opposite the sprocket holes to either the outward deformation of the carrier tape between the embossed cavity or to the edge of the cavity whichever is less.
- The embossment hole location shall be measured from the sprocket hole controlling the location of the embossment. Dimensions of embossment location and hole location shall be applied independent of each other.
- B₁ dimension is a reference dimension for tape feeder clearance only.

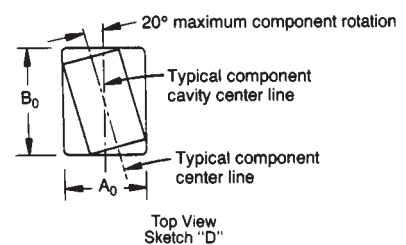
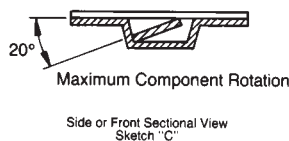

Paper Carrier Configuration



8 & 12mm Tape Only

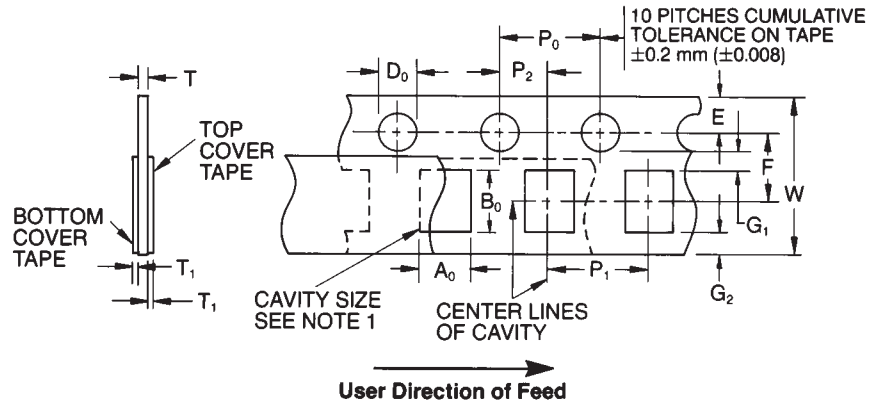

8 & 12mm Paper Tape Metric Dimensions Will Govern

CONSTANT DIMENSIONS

| Tape Size | D ₀ | E | P ₀ | P ₂ | T ₁ | G ₁ | G ₂ | R MIN. |
|--------------|---|------------------------------|-----------------------------|-----------------------------|------------------------|------------------------|------------------------|-------------------------|
| 8mm and 12mm | 1.5 ^{+0.1} _{-0.0} (.059 ^{+0.004} _{-.000}) | 1.75 ± 0.10 (.069 ± .004) | 4.0 ± 0.10 (.157 ± .004) | 2.0 ± 0.05 (.079 ± .002) | 0.10 (.004) Max. | 0.75 (.030) Min. | 0.75 (.030) Min. | 25 (.984) See Note 2 |

VARIABLE DIMENSIONS

| Tape Size | P ₁ | F | W | A ₀ B ₀ | T |
|----------------------|-----------------------------|-----------------------------|---|-------------------------------|------------|
| 8mm | 4.0 ± 0.10 (.157 ± .004) | 3.5 ± 0.05 (.138 ± .002) | 8.0 ^{+0.3} _{-0.1} (.315 ^{+0.012} _{-.004}) | See Note 1 | See Note 3 |
| 12mm | 4.0 ± .010 (.157 ± .004) | 5.5 ± 0.05 (.217 ± .002) | 12.0 ± 0.3 (.472 ± .012) | | |
| 8mm 1/2 Pitch | 2.0 ± 0.10 (.079 ± .004) | 3.5 ± 0.05 (.138 ± .002) | 8.0 ^{+0.3} _{-0.1} (.315 ^{+0.012} _{-.004}) | | |
| 12mm Double Pitch | 8.0 ± 0.10 (.315 ± .004) | 5.5 ± 0.05 (.217 ± .002) | 12.0 ± 0.3 (.472 ± .012) | | |

NOTES:

- A₀, B₀, and T are determined by the max. dimensions to the ends of the terminals extending from the component body and/or the body dimensions of the component. The clearance between the ends of the terminals or body of the component to the sides and depth of the cavity (A₀, B₀, and T) must be within 0.05 mm (.002) min. and 0.50 mm (.020) max. The clearance allowed must also prevent rotation of the component within the cavity of not more than 20 degrees (see sketches A & B).
- Tape with components shall pass around radius "R" without damage.
- 1.1 mm (.043) Base Tape and 1.6 mm (.063) Max. for Non-Paper Base Compositions.

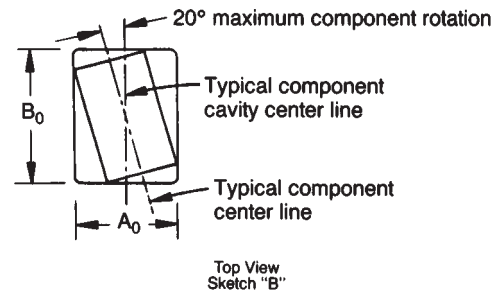
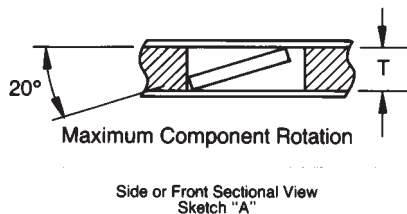

Bar Code Labeling Standard

AVX bar code labeling is available and follows latest version of EIA-556-A.

BENEFITS

- Easier handling
- Smaller packaging volume
(1/20 of T/R packaging)
- Easier inventory control
- Flexibility
- Recyclable

CASE DIMENSIONS

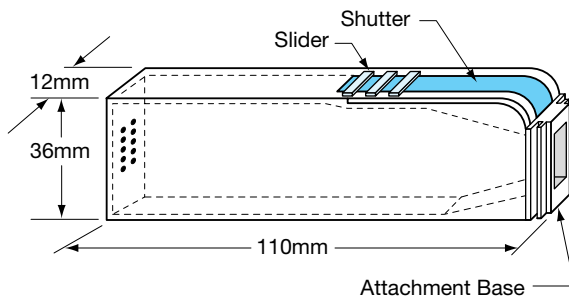

BULK FEEDER

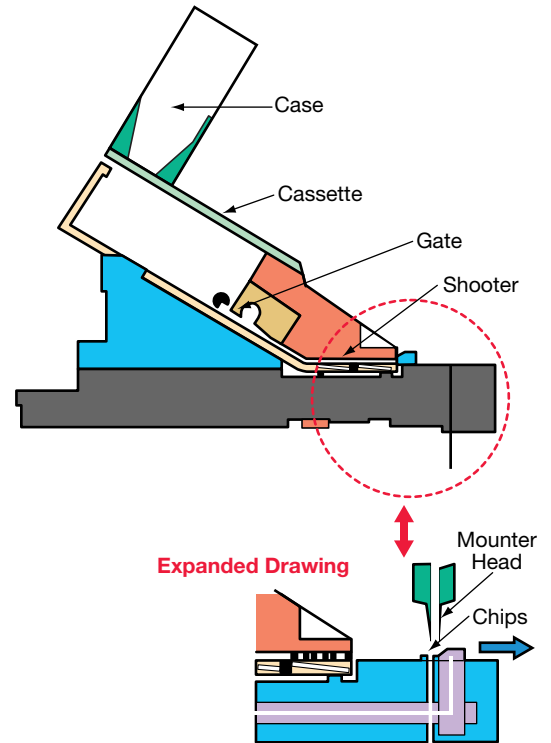

CASE QUANTITIES

| Part Size | 0402 | 0603 | 0805 |
|--------------------------|--------|--------|-------------------------------------|
| Qty. (pcs / cassette) | 80,000 | 15,000 | 10,000 (T=0.6mm) 5,000 (T≥0.6mm) |

Basic Construction – A multilayer ceramic (MLC) capacitor is a monolithic block of ceramic containing two sets of offset, interleaved planar electrodes that extend to two opposite surfaces of the ceramic dielectric. This simple

structure requires a considerable amount of sophistication, both in material and manufacture, to produce it in the quality and quantities needed in today's electronic equipment.

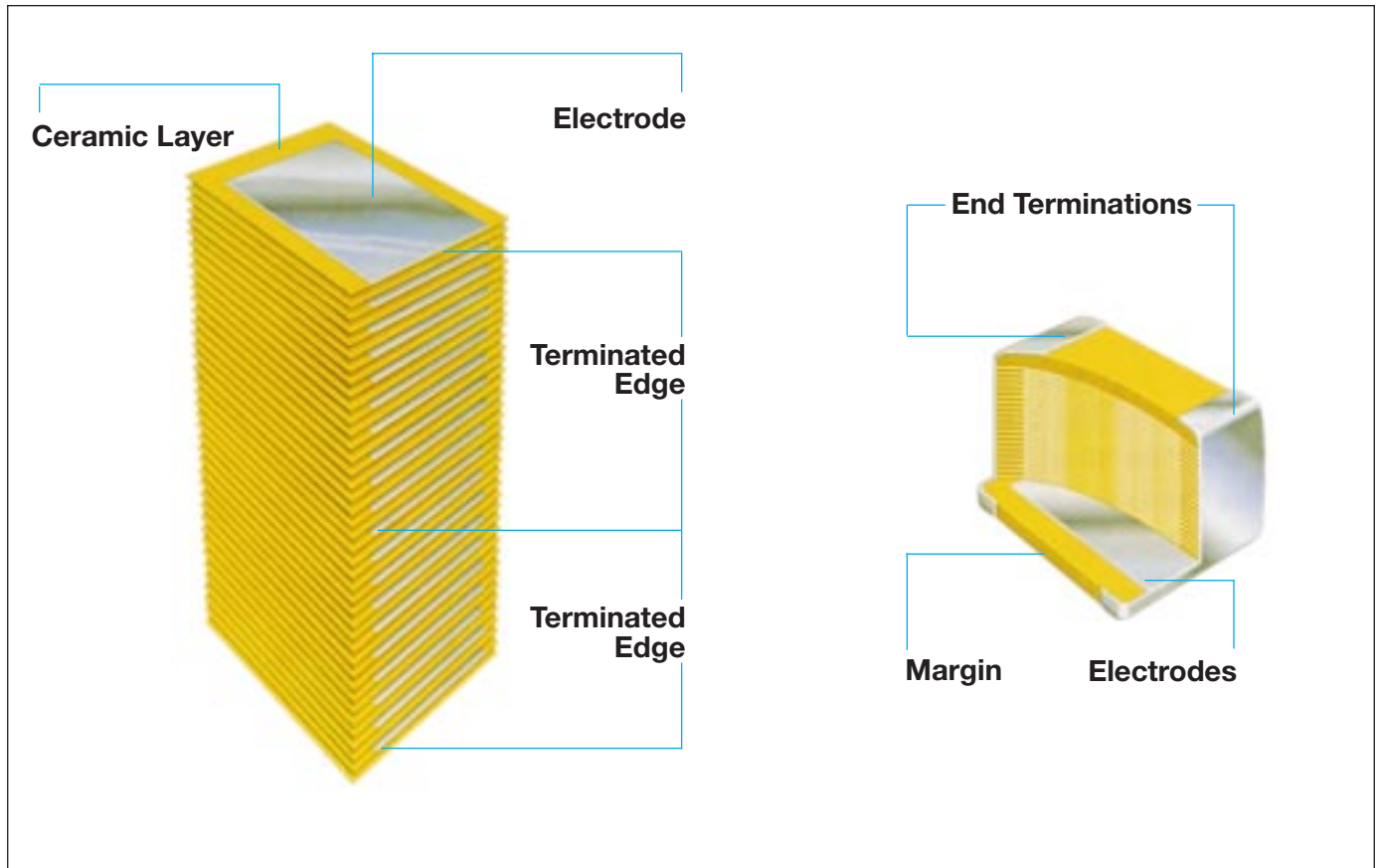

Formulations – Multilayer ceramic capacitors are available in both Class 1 and Class 2 formulations. Temperature compensating formulations are Class 1 and temperature stable and general application formulations are classified as Class 2.

Class 1 – Class 1 capacitors or temperature compensating capacitors are usually made from mixtures of titanates where barium titanate is normally not a major part of the mix. They have predictable temperature coefficients and in general, do not have an aging characteristic. Thus they are the most stable capacitor available. The most popular Class 1 multilayer ceramic capacitors are C0G (NP0) temperature compensating capacitors (negative-positive 0 ppm/°C).

Class 2 – EIA Class 2 capacitors typically are based on the chemistry of barium titanate and provide a wide range of capacitance values and temperature stability. The most commonly used Class 2 dielectrics are X7R and Y5V. The X7R provides intermediate capacitance values which vary only $\pm 15\%$ over the temperature range of -55°C to 125°C . It finds applications where stability over a wide temperature range is required.

The Y5V provides the highest capacitance values and is used in applications where limited temperature changes are expected. The capacitance value for Y5V can vary from 22% to -82% over the -30°C to 85°C temperature range. The Z5U dielectric is between X7R and Y5V in both stability and capacitance range.

All Class 2 capacitors vary in capacitance value under the influence of temperature, operating voltage (both AC and DC), and frequency. For additional information on performance changes with operating conditions, consult AVX's software, SpiCap.

Effects of Voltage – Variations in voltage have little effect on Class 1 dielectric but does affect the capacitance and dissipation factor of Class 2 dielectrics. The application of DC voltage reduces both the capacitance and dissipation factor while the application of an AC voltage within a reasonable range tends to increase both capacitance and dissipation factor readings. If a high enough AC voltage is applied, eventually it will reduce capacitance just as a DC voltage will. Figure 2 shows the effects of AC voltage.

**Cap. Change vs. A.C. Volts
AVX X7R T.C.**

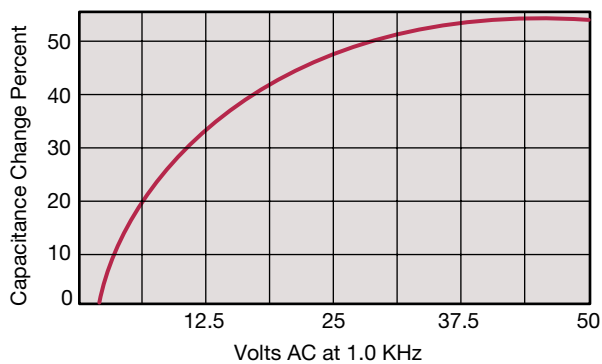

Figure 2

Capacitor specifications specify the AC voltage at which to measure (normally 0.5 or 1 VAC) and application of the wrong voltage can cause spurious readings. Figure 3 gives the voltage coefficient of dissipation factor for various AC voltages at 1 kilohertz. Applications of different frequencies will affect the percentage changes versus voltages.

**D.F. vs. A.C. Measurement Volts
AVX X7R T.C.**

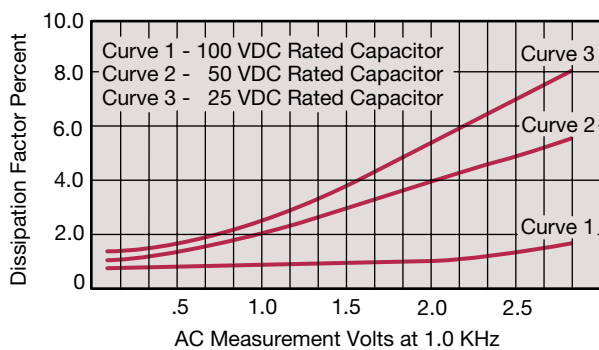

Figure 3

The effect of the application of DC voltage is shown in Figure 4. The voltage coefficient is more pronounced for higher K dielectrics. These figures are shown for room temperature conditions. The combination characteristic known as voltage temperature limits which shows the effects of rated voltage over the operating temperature range is shown in Figure 5 for the military BX characteristic.

**Cap. Change vs. D.C. Volts
AVX X7R T.C.**

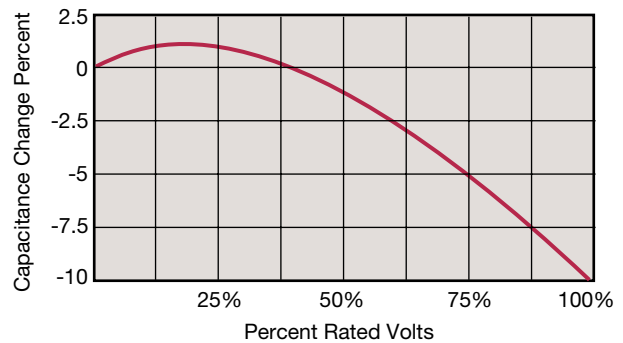

Figure 4

**Typical Cap. Change vs. Temperature
AVX X7R T.C.**

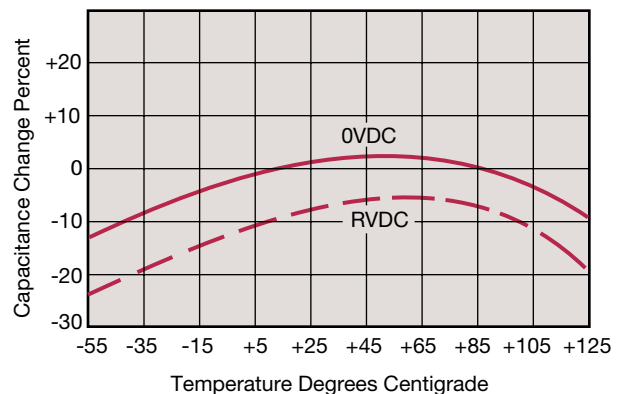

Figure 5

Effects of Time – Class 2 ceramic capacitors change capacitance and dissipation factor with time as well as temperature, voltage and frequency. This change with time is known as aging. Aging is caused by a gradual re-alignment of the crystalline structure of the ceramic and produces an exponential loss in capacitance and decrease in dissipation factor versus time. A typical curve of aging rate for semi-stable ceramics is shown in Figure 6.

If a Class 2 ceramic capacitor that has been sitting on the shelf for a period of time, is heated above its curie point, (125°C for 4 hours or 150°C for ½ hour will suffice) the part will de-age and return to its initial capacitance and dissipation factor readings. Because the capacitance changes rapidly, immediately after de-aging, the basic capacitance measurements are normally referred to a time period sometime after the de-aging process. Various manufacturers use different time bases but the most popular one is one day or twenty-four hours after “last heat.” Change in the aging curve can be caused by the application of voltage and other stresses. The possible changes in capacitance due to de-aging by heating the unit explain why capacitance changes are allowed after test, such as temperature cycling, moisture resistance, etc., in MIL specs. The application of high voltages such as dielectric withstanding voltages also

tends to de-age capacitors and is why re-reading of capacitance after 12 or 24 hours is allowed in military specifications after dielectric strength tests have been performed.

**Typical Curve of Aging Rate
X7R Dielectric**

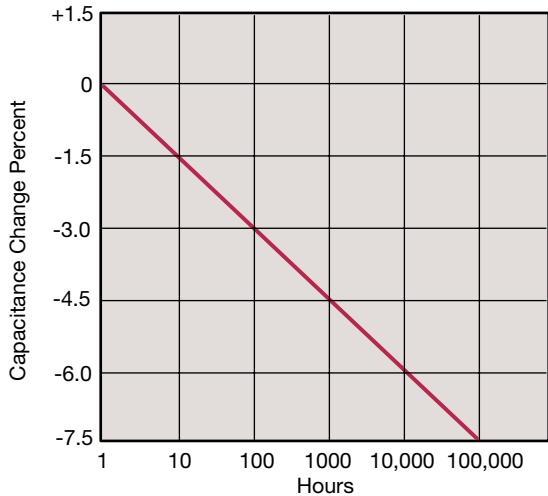

| Characteristic | Max. Aging Rate %/Decade |
|----------------|--------------------------|
| C0G (NPO) | None |
| X7R | 2 |
| Z5U | 3 |
| Y5V | 5 |

Figure 6

Effects of Frequency – Frequency affects capacitance and impedance characteristics of capacitors. This effect is much more pronounced in high dielectric constant ceramic formulation that is low K formulations. AVX’s SpiCap software generates impedance, ESR, series inductance, series resonant frequency and capacitance all as functions of frequency, temperature and DC bias for standard chip sizes and styles. It is available free from AVX.



Effects of Mechanical Stress – High “K” dielectric ceramic capacitors exhibit some low level piezoelectric reactions under mechanical stress. As a general statement, the piezoelectric output is higher, the higher the dielectric constant of the ceramic. It is desirable to investigate this effect before using high “K” dielectrics as coupling capacitors in extremely low level applications.

Reliability – Historically ceramic capacitors have been one of the most reliable types of capacitors in use today. The approximate formula for the reliability of a ceramic capacitor is:

$$\frac{L_o}{L_t} = \left(\frac{V_t}{V_o}\right)^X \left(\frac{T_t}{T_o}\right)^Y$$

where

- L_o = operating life
- L_t = test life
- V_t = test voltage
- V_o = operating voltage
- T_t = test temperature and
- T_o = operating temperature in °C
- X, Y = see text

Historically for ceramic capacitors exponent X has been considered as 3. The exponent Y for temperature effects typically tends to run about 8.

A capacitor is a component which is capable of storing electrical energy. It consists of two conductive plates (electrodes) separated by insulating material which is called the dielectric. A typical formula for determining capacitance is:

$$C = \frac{.224 KA}{t}$$

- C = capacitance (picofarads)
- K = dielectric constant (Vacuum = 1)
- A = area in square inches
- t = separation between the plates in inches (thickness of dielectric)
- $.224$ = conversion constant (.0884 for metric system in cm)

Capacitance – The standard unit of capacitance is the farad. A capacitor has a capacitance of 1 farad when 1 coulomb charges it to 1 volt. One farad is a very large unit and most capacitors have values in the micro (10^{-6}), nano (10^{-9}) or pico (10^{-12}) farad level.

Dielectric Constant – In the formula for capacitance given above the dielectric constant of a vacuum is arbitrarily chosen as the number 1. Dielectric constants of other materials are then compared to the dielectric constant of a vacuum.

Dielectric Thickness – Capacitance is indirectly proportional to the separation between electrodes. Lower voltage requirements mean thinner dielectrics and greater capacitance per volume.

Area – Capacitance is directly proportional to the area of the electrodes. Since the other variables in the equation are usually set by the performance desired, area is the easiest parameter to modify to obtain a specific capacitance within a material group.

General Description



Energy Stored – The energy which can be stored in a capacitor is given by the formula:

$$E = \frac{1}{2}CV^2$$

- E** = energy in joules (watts-sec)
- V** = applied voltage
- C** = capacitance in farads

Potential Change – A capacitor is a reactive component which reacts against a change in potential across it. This is shown by the equation for the linear charge of a capacitor:

$$I_{ideal} = C \frac{dV}{dt}$$

where

- I** = Current
- C** = Capacitance
- dV/dt** = Slope of voltage transition across capacitor

Thus an infinite current would be required to instantly change the potential across a capacitor. The amount of current a capacitor can “sink” is determined by the above equation.

Equivalent Circuit – A capacitor, as a practical device, exhibits not only capacitance but also resistance and inductance. A simplified schematic for the equivalent circuit is:

- C** = Capacitance
- L** = Inductance
- R_s** = Series Resistance
- R_p** = Parallel Resistance

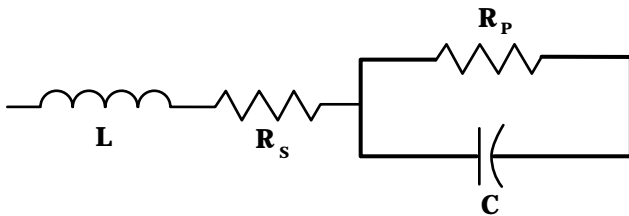

Reactance – Since the insulation resistance (R_p) is normally very high, the total impedance of a capacitor is:

$$Z = \sqrt{R_s^2 + (X_c - X_L)^2}$$

where

- Z** = Total Impedance
- R_s** = Series Resistance
- X_c** = Capacitive Reactance = $\frac{1}{2\pi fC}$
- X_L** = Inductive Reactance = $2\pi fL$

The variation of a capacitor’s impedance with frequency determines its effectiveness in many applications.

Phase Angle – Power Factor and Dissipation Factor are often confused since they are both measures of the loss in a capacitor under AC application and are often almost identical in value. In a “perfect” capacitor the current in the capacitor will lead the voltage by 90°.

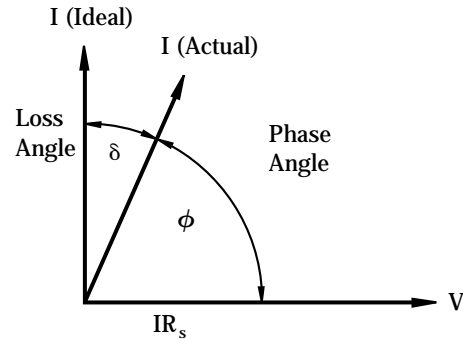

In practice the current leads the voltage by some other phase angle due to the series resistance R_s . The complement of this angle is called the loss angle and:

- Power Factor (P.F.) = $\cos \phi$ or $\sin \delta$
- Dissipation Factor (D.F.) = $\tan \delta$

for small values of δ the tan and sine are essentially equal which has led to the common interchangeability of the two terms in the industry.

Equivalent Series Resistance – The term E.S.R. or Equivalent Series Resistance combines all losses both series and parallel in a capacitor at a given frequency so that the equivalent circuit is reduced to a simple R-C series connection.

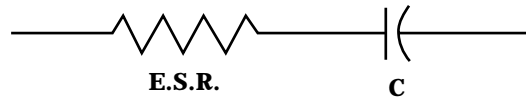

Dissipation Factor – The DF/PF of a capacitor tells what percent of the apparent power input will turn to heat in the capacitor.

$$\text{Dissipation Factor} = \frac{E.S.R.}{X_c} = (2\pi fC) (E.S.R.)$$

The watts loss are:

$$\text{Watts loss} = (2\pi fCV^2) (D.F.)$$

Very low values of dissipation factor are expressed as their reciprocal for convenience. These are called the “Q” or Quality factor of capacitors.

Parasitic Inductance – The parasitic inductance of capacitors is becoming more and more important in the decoupling of today’s high speed digital systems. The relationship between the inductance and the ripple voltage induced on the DC voltage line can be seen from the simple inductance equation:

$$V = L \frac{di}{dt}$$

The $\frac{di}{dt}$ seen in current microprocessors can be as high as 0.3 A/ns, and up to 10A/ns. At 0.3 A/ns, 100pH of parasitic inductance can cause a voltage spike of 30mV. While this does not sound very drastic, with the Vcc for microprocessors decreasing at the current rate, this can be a fairly large percentage.

Another important, often overlooked, reason for knowing the parasitic inductance is the calculation of the resonant frequency. This can be important for high frequency, bypass capacitors, as the resonant point will give the most signal attenuation. The resonant frequency is calculated from the simple equation:

$$f_{res} = \frac{1}{2\pi\sqrt{LC}}$$

Insulation Resistance – Insulation Resistance is the resistance measured across the terminals of a capacitor and consists principally of the parallel resistance R_P shown in the equivalent circuit. As capacitance values and hence the area of dielectric increases, the I.R. decreases and hence the product (C x IR or RC) is often specified in ohm farads or more commonly megohm-microfarads. Leakage current

is determined by dividing the rated voltage by IR (Ohm's Law).

Dielectric Strength – Dielectric Strength is an expression of the ability of a material to withstand an electrical stress. Although dielectric strength is ordinarily expressed in volts, it is actually dependent on the thickness of the dielectric and thus is also more generically a function of volts/mil.

Dielectric Absorption – A capacitor does not discharge instantaneously upon application of a short circuit, but drains gradually after the capacitance proper has been discharged. It is common practice to measure the dielectric absorption by determining the “reappearing voltage” which appears across a capacitor at some point in time after it has been fully discharged under short circuit conditions.

Corona – Corona is the ionization of air or other vapors which causes them to conduct current. It is especially prevalent in high voltage units but can occur with low voltages as well where high voltage gradients occur. The energy discharged degrades the performance of the capacitor and can in time cause catastrophic failures.

Surface Mounting Guide



MLC Chip Capacitors

Component Pad Design

Component pads should be designed to achieve good solder filets and minimize component movement during reflow soldering. Pad designs are given below for the most common sizes of multilayer ceramic capacitors for both wave and reflow soldering. The basis of these designs is:

- Pad width equal to component width. It is permissible to decrease this to as low as 85% of component width but it is not advisable to go below this.
- Pad overlap 0.5mm beneath component.
- Pad extension 0.5mm beyond components for reflow and 1.0mm for wave soldering.

REFLOW SOLDERING

| Case Size | D1 | D2 | D3 | D4 | D5 |
|-------------|-------------|--------------|-------------|-------------|-------------|
| 0402 | 1.70 (0.07) | 0.60 (0.02) | 0.50 (0.02) | 0.60 (0.02) | 0.50 (0.02) |
| 0603 | 2.30 (0.09) | 0.80 (0.03) | 0.70 (0.03) | 0.80 (0.03) | 0.75 (0.03) |
| 0805 | 3.00 (0.12) | 1.00 (0.04) | 1.00 (0.04) | 1.00 (0.04) | 1.25 (0.05) |
| 1206 | 4.00 (0.16) | 1.00 (0.04) | 2.00 (0.09) | 1.00 (0.04) | 1.60 (0.06) |
| 1210 | 4.00 (0.16) | 1.00 (0.04) | 2.00 (0.09) | 1.00 (0.04) | 2.50 (0.10) |
| 1808 | 5.60 (0.22) | 1.00 (0.04) | 3.60 (0.14) | 1.00 (0.04) | 2.00 (0.08) |
| 1812 | 5.60 (0.22) | 1.00 (0.04)) | 3.60 (0.14) | 1.00 (0.04) | 3.00 (0.12) |
| 1825 | 5.60 (0.22) | 1.00 (0.04) | 3.60 (0.14) | 1.00 (0.04) | 6.35 (0.25) |
| 2220 | 6.60 (0.26) | 1.00 (0.04) | 4.60 (0.18) | 1.00 (0.04) | 5.00 (0.20) |
| 2225 | 6.60 (0.26) | 1.00 (0.04) | 4.60 (0.18) | 1.00 (0.04) | 6.35 (0.25) |

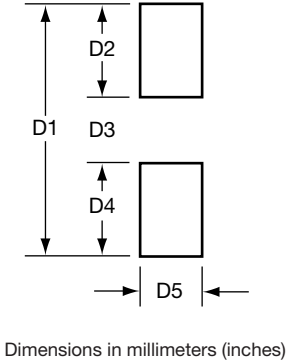

WAVE SOLDERING

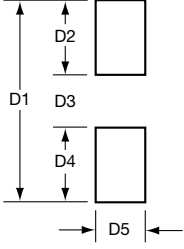

| Case Size | D1 | D2 | D3 | D4 | D5 |
|-------------|-------------|-------------|-------------|-------------|-------------|
| 0603 | 3.10 (0.12) | 1.20 (0.05) | 0.70 (0.03) | 1.20 (0.05) | 0.75 (0.03) |
| 0805 | 4.00 (0.15) | 1.50 (0.06) | 1.00 (0.04) | 1.50 (0.06) | 1.25 (0.05) |
| 1206 | 5.00 (0.19) | 1.50 (0.06) | 2.00 (0.09) | 1.50 (0.06) | 1.60 (0.06) |
| 1210 | 5.00 (0.19) | 1.50 (0.06) | 2.00 (0.09) | 1.50 (0.06) | 2.50 (0.10) |

Dimensions in millimeters (inches)

Component Spacing

For wave soldering components, must be spaced sufficiently far apart to avoid bridging or shadowing (inability of solder to penetrate properly into small spaces). This is less important for reflow soldering but sufficient space must be allowed to enable rework should it be required.

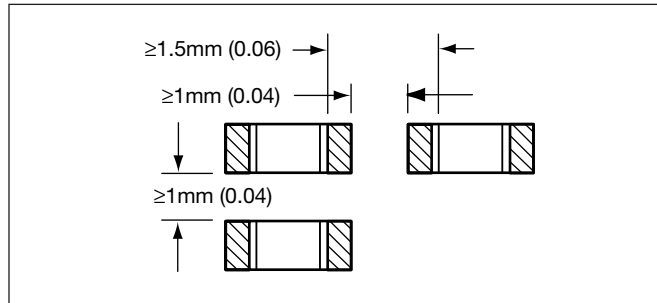

Preheat & Soldering

The rate of preheat should not exceed 4°C/second to prevent thermal shock. A better maximum figure is about 2°C/second.

For capacitors size 1206 and below, with a maximum thickness of 1.25mm, it is generally permissible to allow a temperature differential from preheat to soldering of 150°C. In all other cases this differential should not exceed 100°C.

For further specific application or process advice, please consult AVX.

Cleaning

Care should be taken to ensure that the capacitors are thoroughly cleaned of flux residues especially the space beneath the capacitor. Such residues may otherwise become conductive and effectively offer a low resistance bypass to the capacitor.

Ultrasonic cleaning is permissible, the recommended conditions being 8 Watts/litre at 20-45 kHz, with a process cycle of 2 minutes vapor rinse, 2 minutes immersion in the ultrasonic solvent bath and finally 2 minutes vapor rinse.

MLC Chip Capacitors

APPLICATION NOTES

Storage

Good solderability is maintained for at least twelve months, provided the components are stored in their “as received” packaging at less than 40°C and 70% RH.

Solderability

Terminations to be well soldered after immersion in a 60/40 tin/lead solder bath at 235 ±5°C for 2±1 seconds.

Leaching

Terminations will resist leaching for at least the immersion times and conditions shown below.

| Termination Type | Solder Tin/Lead/Silver | Solder Temp. °C | Immersion Time Seconds |
|------------------|------------------------|-----------------|------------------------|
| Nickel Barrier | 60/40/0 | 260±5 | 30±1 |

Recommended Soldering Profiles

Reflow

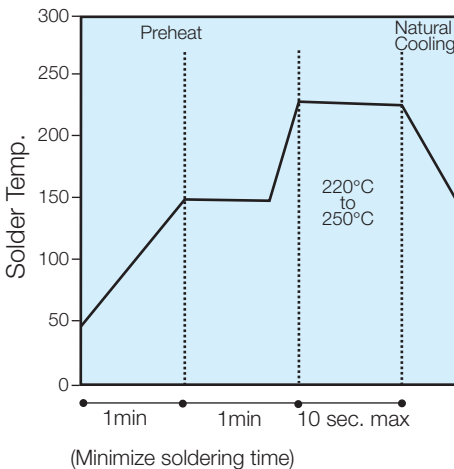

Wave

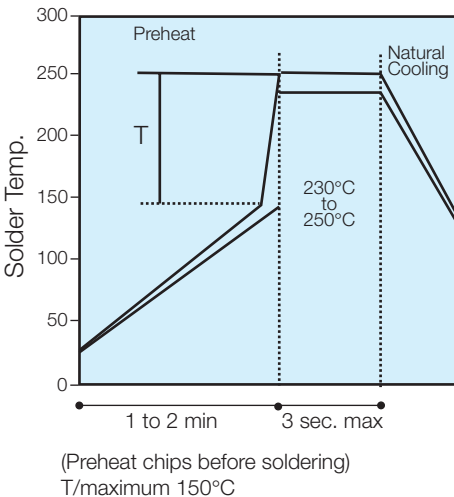

General

Surface mounting chip multilayer ceramic capacitors are designed for soldering to printed circuit boards or other substrates. The construction of the components is such that they will withstand the time/temperature profiles used in both wave and reflow soldering methods.

Handling

Chip multilayer ceramic capacitors should be handled with care to avoid damage or contamination from perspiration and skin oils. The use of tweezers or vacuum pick ups is strongly recommended for individual components. Bulk handling should ensure that abrasion and mechanical shock are minimized. Taped and reeled components provides the ideal medium for direct presentation to the placement machine. Any mechanical shock should be minimized during handling chip multilayer ceramic capacitors.

Preheat

It is important to avoid the possibility of thermal shock during soldering and carefully controlled preheat is therefore required. The rate of preheat should not exceed 4°C/second and a target figure 2°C/second is recommended. Although an 80°C to 120°C temperature differential is preferred, recent developments allow a temperature differential between the component surface and the soldering temperature of 150°C (Maximum) for capacitors of 1210 size and below with a maximum thickness of 1.25mm. The user is cautioned that the risk of thermal shock increases as chip size or temperature differential increases.

Soldering

Mildly activated rosin fluxes are preferred. The minimum amount of solder to give a good joint should be used. Excessive solder can lead to damage from the stresses caused by the difference in coefficients of expansion between solder, chip and substrate. AVX terminations are suitable for all wave and reflow soldering systems. If hand soldering cannot be avoided, the preferred technique is the utilization of hot air soldering tools.

Cooling

Natural cooling in air is preferred, as this minimizes stresses within the soldered joint. When forced air cooling is used, cooling rate should not exceed 4°C/second. Quenching is not recommended but if used, maximum temperature differentials should be observed according to the preheat conditions above.

Cleaning

Flux residues may be hygroscopic or acidic and must be removed. AVX MLC capacitors are acceptable for use with all of the solvents described in the specifications MIL-STD-202 and EIA-RS-198. Alcohol based solvents are acceptable and properly controlled water cleaning systems are also acceptable. Many other solvents have been proven successful, and most solvents that are acceptable to other components on circuit assemblies are equally acceptable for use with ceramic capacitors.

Internet –

For more information visit us on the worldwide web at
<http://www.avxcorp.com>

FAX Back Service –

Just dial 1-800-879-1613 and request the index for additional catalog information faxed to your FAX number.

CD ROM –

Or get in touch with your AVX representative for a CD Rom or copies of the catalogs and technical papers.

Software –

Comprehensive capacitor application software library which includes:

- SpiCap (for MLC chip capacitors)
- SpiTan (for tantalum capacitors)
- SpiCalci (for power supply capacitors)
- SpiMic (for RF-Microwave capacitors)

**For AVX/Elco connector information contact your local
AVX/Elco representative**

NOTICE: Specifications are subject to change without notice. Contact your nearest AVX Sales Office for the latest specifications. All statements, information and data given herein are believed to be accurate and reliable, but are presented without guarantee, warranty, or responsibility of any kind, expressed or implied. Statements or suggestions concerning possible use of our products are made without representation or warranty that any such use is free of patent infringement and are not recommendations to infringe any patent. The user should not assume that all safety measures are indicated or that other measures may not be required. Specifications are typical and may not apply to all applications.

USA

AVX Myrtle Beach, SC Corporate Offices

Tel: 843-448-9411
FAX: 843-448-1943

AVX Northwest, WA

Tel: 360-669-8746
FAX: 360-699-8751

AVX North Central, IN

Tel: 317-848-7153
FAX: 317-844-9314

AVX Northeast, MA

Tel: 508-485-8114
FAX: 508-485-8471

AVX Mid-Pacific, CA

Tel: 408-436-5400
FAX: 408-437-1500

AVX Southwest, AZ

Tel: 602-539-1496
FAX: 602-539-1501

AVX South Central, TX

Tel: 972-669-1223
FAX: 972-669-2090

AVX Southeast, NC

Tel: 919-878-6357
FAX: 919-878-6462

AVX Canada

Tel: 905-564-8959
FAX: 905-564-9728

EUROPE

AVX Limited, England European Headquarters

Tel: ++44 (0)1252 770000
FAX: ++44 (0)1252 770001

AVX S.A., France

Tel: ++33 (1) 69.18.46.00
FAX: ++33 (1) 69.28.73.87

AVX GmbH, Germany - AVX

Tel: ++49 (0) 8131 9004-0
FAX: ++49 (0) 8131 9004-44

AVX GmbH, Germany - Elco

Tel: ++49 (0) 2741 2990
FAX: ++49 (0) 2741 299133

AVX srl, Italy

Tel: ++390 (0)2 614571
FAX: ++390 (0)2 614 2576

AVX sro, Czech Republic

Tel: ++420 (0)467 558340
FAX: ++420 (0)467 2844

ASIA-PACIFIC

AVX/Kyocera, Singapore Asia-Pacific Headquarters

Tel: (65) 258-2833
FAX: (65) 350-4880

AVX/Kyocera, Hong Kong

Tel: (852) 2-363-3303
FAX: (852) 2-765-8185

AVX/Kyocera, Korea

Tel: (82) 2-785-6504
FAX: (82) 2-784-5411

AVX/Kyocera, Taiwan

Tel: (886) 2-2516-7010
FAX: (886) 2-2506-9774

AVX/Kyocera, China

Tel: (86) 21-6249-0314-16
FAX: (86) 21-6249-0313

AVX/Kyocera, Malaysia

Tel: (60) 4-228-1190
FAX: (60) 4-228-1196

Elco, Japan

Tel: 045-943-2906/7
FAX: 045-943-2910

Kyocera, Japan

Tel: (81) 75-593-4518
FAX: (81) 75-502-2705

Contact:

